

News
19/
20



Visti al Salone

Eleganti dettagli in pelle e tessuto caratterizzano i nuovi modelli di imbottiti Nicoline - Nova, Manzoni, Ghisolfi e Cavour. Sono stati presentati in anteprima al Salone del Mobile 2019 insieme ai già presenti in collezione Cairoli, Cadorna e Zara Cuoio. Forme morbide e confortevoli si accompagnano a poggiatesta mobili e a preziosi inserti in cuoio e marmo. Quattro novità, caratterizzate da altrettante palette di finiture, si articolano in diverse composizioni, adattandosi a qualsiasi esigenza di disposizione e colore.

\\

Elegant leather and fabric details make Nicoline's new styles original - Nova, Manzoni, Ghisolfi and Cavour. They were introduced in preview, during Salone del Mobile show 2019, together with Cairoli, Cadorna and Zara Cuoio already present in our collection. Equipped with movable headrests our models are characterized by their soft and comfortable shapes and their precious hide leather and marble details. These novelties, that can be combined in different compositions, are enriched with many finishing palettes adapting to any requirement and color.



Indice

Index

Cavour

p. 42
/ 47



NEW

Ghisolfa

p. 32
/ 41



NEW

Manzoni

p. 18
/ 31



NEW

Nova

p. 6
/ 17



NEW

Nova

Design Application n° 402019000000467



1. PELLE / LEATHER ROYAL Col.2363 Cat.2000
2. TESSUTO / FABRIC L1634/SER Col.13 Cat.G
3. TESSUTO / FABRIC L1635/GRI Col.07 Cat.G
4. PELLE / LEATHER NABUK Col.5008 Cat.5000
5. PELLE / LEATHER NABUK Col.5001 Cat.5000
6. METALLO CANNA DI FUCILE / GUNMENTAL (Cod.50)
7. TESSUTO / FABRIC L1629/LOC Col.01 Cat.G







Piedi
Legs

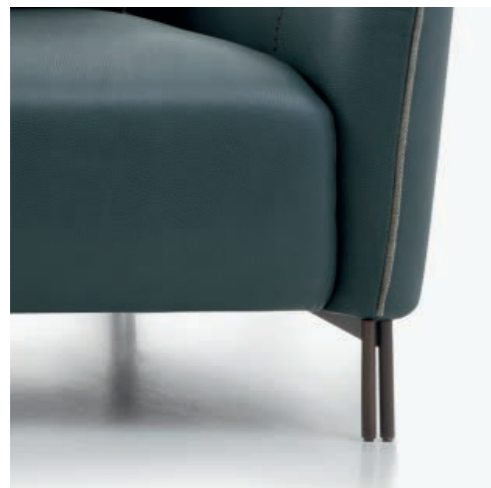

-  Canna di fucile / Gunmetal Cod.50
-  Bronzo anticato / Antique bronze Cod.52

Poggiareni
Lumbar cushions

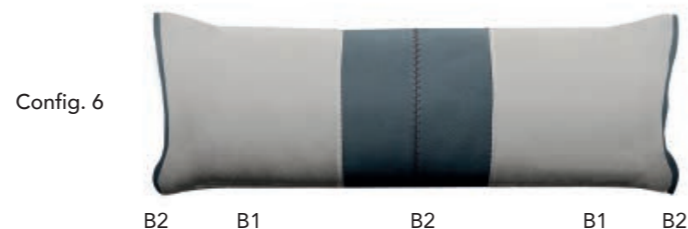
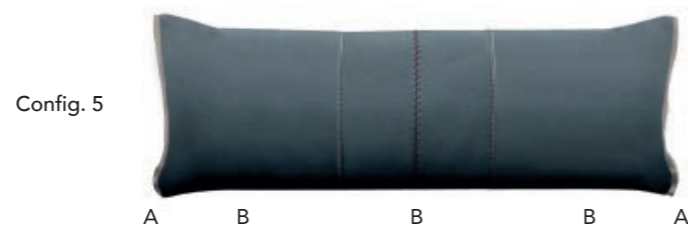
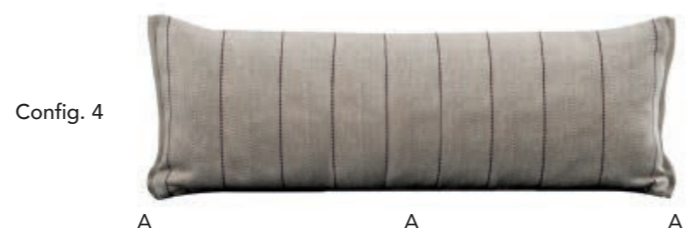
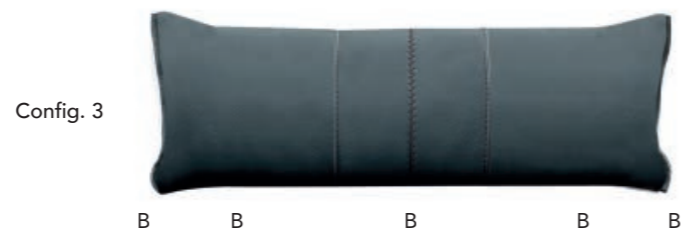
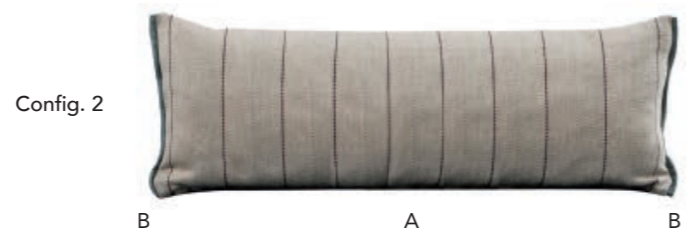
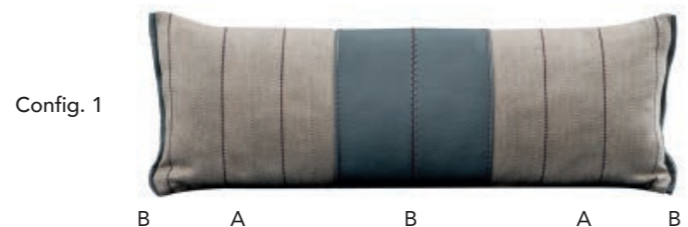

A, A1, A2: Tessuto / Fabric
B, B1, B2: Pelle / Leather





Manzoni Cuoio

Design Application n° 402019000000467



- 1. TESSUTO / FABRIC L1630/LOH Col.01 Cat.G
- 2. TESSUTO / FABRIC L1552/EGI Col.36 Cat.G
- 3. TESSUTO / FABRIC L1593/ETA Col.15 Cat.G
- 4. TESSUTO / FABRIC L1552/EGI Col.08 Cat.G
- 5. MARMO EMPERADOR / EMPERADOR MARBLE (Cod.EM)
- 6. PELLE / LEATHER NABUK Col.5003 Cat.5000
- 7. METALLO CANNA DI FUCILE / GUNMENTAL (Cod.50)
- 8. TESSUTO / FABRIC L1534/AVO Col.13 Cat.G





La versione Cod. 8135 deve essere
interposta solo tra due
elementi con seduta a martello.













\\

The version Cod. 8135 can be selected
only for two elements with hammer seat.

Bordino
Piping



Bordino "Gros grain" disponibile nei colori:
Gros grain piping available in the following colors:

 Foresta / Forrest Col.170	 Panna / Cream Col.37
 Argento / Silver Col.48	 Tortora / Taupe Col.164
 Pavone / Peacock Col.139	 Senape / Mustard Col.63
 Avio / Sky Col.173	 Ambra / Amber Col.68
 Oceano / Ocean Col.116	 Caffè / Coffee Col.101
 Sabbia / Sand Col.136	 Melanzana / Aubergine Col.91





Bracciolo Manzoni Light

Manzoni Light Armrest



Bracciolo Manzoni Cuoio

Manzoni Cuoio Armrest



Bracciolo Manzoni

Manzoni Armrest



Bracciolo disponibile nei colori cuoio:
Armrest available in the following colors of hide leather:



Avorio /
Ivory
Col.C01



Tortora /
Taupe
Col.C05



Sabbia /
Sand
Col.C02



Grigio scuro /
Dark grey
Col.C06



Naturale /
Natural
Col.C03



Verde fango /
Mud green
Col.C08



Terracotta /
Terracotta
Col.C04



Testa di moro /
Dark brown
Col.C10



Terminale Manzoni Light
Terminal Light Armrest



Terminale Manzoni Cuoio
Terminal Cuoio Armrest



Manzoni
Terminal Armrest



Terminale disponibile nei colori cuoio:
Terminal available in the following colors of hide leather:

- | | |
|--|---|
|  Avorio / Ivory
Col.C01 |  Tortora / Taupe
Col.C05 |
|  Sabbia / Sand
Col.C02 |  Grigio scuro / Dark grey
Col.C06 |
|  Naturale / Natural
Col.C03 |  Verde fango / Mud green
Col.C08 |
|  Terracotta / Terracotta
Col.C04 |  Testa di moro / Dark brown
Col.C10 |



Ghisolfa

Design Application n° 402019000000467



- 1. TESSUTO / FABRIC L1629/LOC Col.05 Cat.G
- 2. PELLE / LEATHER NABUK COL.5010 - EFFETTO TRECCIA (BRAIDED NABUK) Cat.5000
- 3. PELLE / LEATHER NABUK Col.5010 Cat.5000
- 4. PELLE / LEATHER COLORADO Col.2560 Cat.2500
- 5. MARMO EMPERADOR / EMPERADOR MARBLE (Cod.EM)
- 6. PELLE / LEATHER NABUK Col.5005 Cat.5000
- 7. METALLO CANNA DI FUCILE / GUNMENTAL (Cod.50)
- 8. TESSUTO / FABRIC L1552 / EGI Col.26 Cat.G





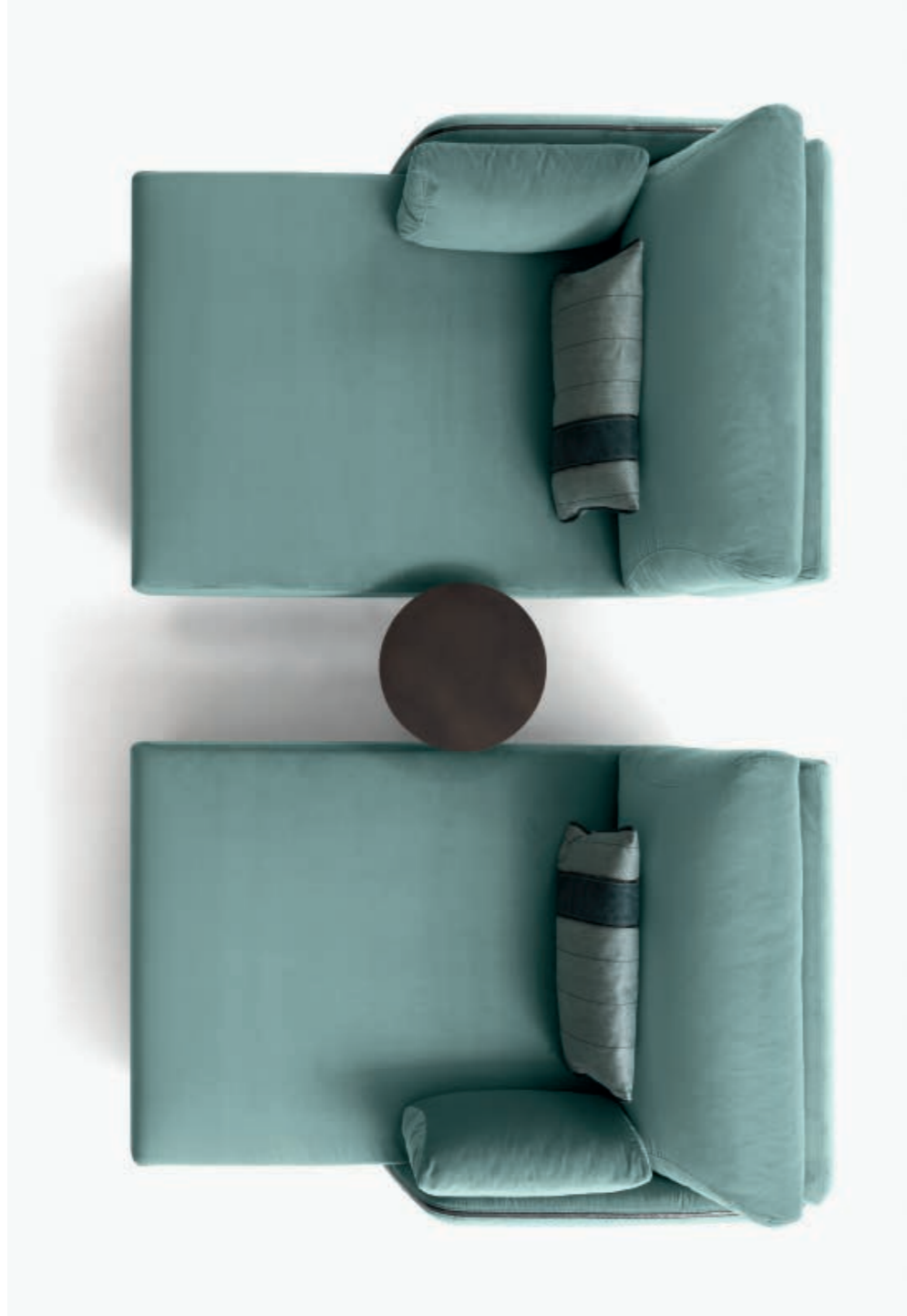

Bracciolo
Armrest



Cerniera
Zip



Piedi
Legs

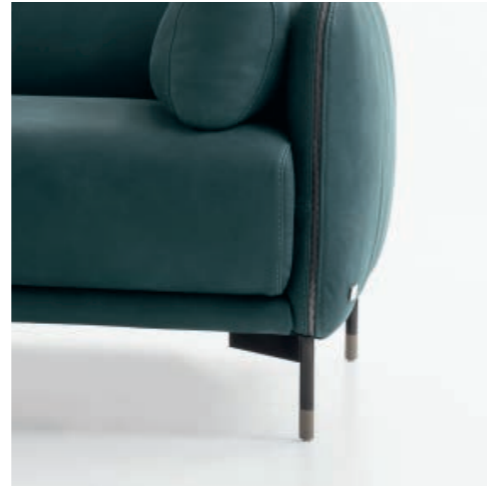

Canna di fucile /
Gunmetal
Cod.50

Canna di fucile con parte inferiore verniciata in
colore oro satinato.
Gunmetal with lower part painted in matte gold
color.



Canna di fucile /
Gunmetal
Cod.50



Oro
Satinato /
Matte gold
color



Cavour

Design Application n° 402019000000467



1. TESSUTO / FABRIC L1630/LOH Col.04 Cat.G
2. PELLE / LEATHER NABUK Col.5003 - EFFETTO INTRECCIO 2" (BRAIDED NABUK 2) Cat.5000
3. TESSUTO / FABRIC L1634/SER Col.34 Cat.G
4. PELLE / LEATHER NABUK Col.5007 Cat.5000
5. MARMO CARRARA BIANCO / CARRARA WHITE MARBLE (Cod.CA)
6. PELLE / LEATHER COLORADO Col.2562 Cat.2500
7. METALLO CANNA DI FUCILE / GUNMENTAL (Cod.50)
8. PELLE / LEATHER NOBILE Col.3058 Cat.3500



Poggiatesta
Headrest



Piedi
Legs



Cuciture
Stitching



-  Metallo lucido /
Shiny metal
Cod.30
-  Metallo satinato /
Satin metal
Cod.31
-  Canna di fucile /
Gunmetal
Cod.50

Cucitura Cod.210
Stitching Cod.210



Cuscini

/ Pillows

NEW



CU 73 60x30 cm
24"x12"



CARATTERISTICHE STANDARD

- Imbottitura in misto piuma.
- Rivestimento coordinato in pelle e tessuto.
- Cucitura Cod.03.
- Cerniera con finitura Canna di fucile (Cod.CF).
- **Si prega di specificare i rivestimenti A (tessuto) e B (pelle), secondo schema di seguito riportato.**

NOTE

- Non è possibile variare la tipologia dei rivestimenti.

STANDARD FEATURES

- Mixed feather.
- Combined covering in leather and fabric.
- Stitching type Cod.03.
- Zipper in Gunmetal (Cod.CF).
- **Please specify covering colors for A (fabric) and B (leather) as per the following scheme.**

NOTES

- It is not possible to choose a different type of covering.



CU 75 58x48 cm
23"x19"

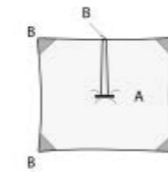

CARATTERISTICHE STANDARD

- Imbottitura in misto piuma.
- Rivestimento coordinato in pelle e tessuto.
- Bottone in metallo con finitura Canna di fucile (Cod.CF).
- **Si prega di specificare i rivestimenti A (tessuto) e B (pelle), secondo schema di seguito riportato.**

NOTE

- Non è possibile variare la tipologia dei rivestimenti.

STANDARD FEATURES

- Mixed feather.
- Combined covering in leather and fabric.
- Metal button in Gunmetal (Cod.CF).
- **Please specify covering colors for A (fabric) and B (leather) as per the following scheme.**

NOTES

- It is not possible to choose a different type of covering.



CU 74 60x30 cm
24"x12"



CARATTERISTICHE STANDARD

- Imbottitura in misto piuma.
- Rivestimento coordinato in pelle e tessuto.
- Cucitura Cod.03 e Cod.11.
- **Si prega di specificare i rivestimenti A (tessuto) e B (pelle), secondo schema di seguito riportato.**

NOTE

- Non è possibile variare la tipologia dei rivestimenti.

STANDARD FEATURES

- Mixed feather.
- Combined covering in leather and fabric.
- Stitching type Cod.03 and Cod.11.
- **Please specify covering colors for A (fabric) and B (leather) as per the following scheme.**

NOTES

- It is not possible to choose a different type of covering.



CU 76 60x30 cm
24"x12"



CARATTERISTICHE STANDARD

- Imbottitura in misto piuma.
- Rivestimento coordinato in pelle e tessuto.
- Cucitura Cod.116.
- **Si prega di specificare i rivestimenti A (tessuto) e B (pelle), secondo schema di seguito riportato.**

NOTE

- Non è possibile variare la tipologia dei rivestimenti.

STANDARD FEATURES

- Mixed feather.
- Combined covering in leather and fabric.
- Stitching type Cod.116.
- **Please specify covering colors for A (fabric) and B (leather) as per the following scheme.**

NOTES

- It is not possible to choose a different type of covering.

Descrizione Foto

/Description of the photographs



p. 044 / 045

Cavour

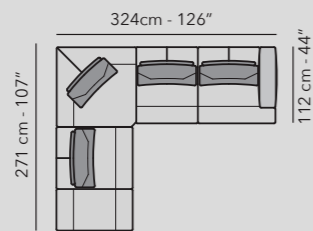

Cavour (Cod.3001+ 4304+1602)

Pelle: Nobile Col.3058 Cat.3000
Piedi in metallo: Canna di fucile (Cod.50)

Cuscini:

n°01 Cod.CU50 tessuto: L1552/EGI Col.33 Cat.G - Collezione Milano Fabrics
n°01 Cod.CU57 tessuto: L1597/TRA Col.04 Cat.G - Collezione Florence

Moscova (Cod.1000)

Tessuto: L1597/TRA Col.04 Cat.G - Collezione Florence
Struttura in metallo: Canna di fucile (Cod.50)

Tavolino Fly (Cod.T909)

Struttura in metallo: Bronzo anticato (Cod.52)

Cavour (Cod.3001+4504+1602)

Leather: Nobile Col.3058 Cat.3000
Metal legs: Gunmetal (Cod.50)

Pillows:

Q.ty 01 Cod.CU50 fabric: L1552/EGI Col.33 Cat.G - Milano Fabrics Collection
Q.ty 01 Cod.CU57 fabric: L1597/TRA Col.04 Cat.G - Florence Collection

Moscova (Cod.1000)

Fabric: L1597/TRA Col.04 Cat.G - Florence Collection
Metal structure: Gunmetal (Cod.50)

Coffee Table Fly (Cod.T909)

Metal structure: Antique bronze (Cod.52)



p. 034 / 035

Ghisolfa

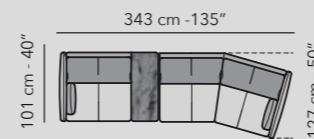

Ghisolfa (Cod.1732+3091)

Pelle: Colorado Col.2560 Cat.2500
Piedi in metallo: Canna di fucile (Cod.50) con parte inferiore verniciata in colore oro satinato

Lima (Cod.1000 x 2)

Rivestimento coordinato: tessuto L1629/LOC Col.05 Cat.G - Collezione Milano Fabrics / pelle Nabuk Col.5008 Cat.5000
Struttura in metallo: Bronzo anticato (Cod.52)

Cuscini:

n°01 Cod.CU73 Rivestimento coordinato: tessuto L1629/LOC Col.05 Cat.G - Collezione Milano Fabrics / pelle Colorado Col.2560 Cat.2500

Tavolino Astratto (Cod.T900 x 2)

Ripiano: Vetro stampato (Cod.VS)
Struttura in metallo: Canna di fucile (Cod.50)

Ghisolfa (Cod.1732+3091)

Leather: Colorado Col.2560 Cat.2500
Metal legs: Gunmetal (Cod.50) with lower part painted in matte gold color

Lima (Cod.1000 x 2)

Combined coverings: fabric L1629/LOC Col.05 Cat.G - Milano Fabrics Collection / leather Nabuk Col.5008 Cat.5000
Metal structure: Antique bronze (Cod.52)

Pillows:

Q.ty 01 Cod.CU73 Combined coverings: fabric L1629/LOC Col.05 Cat.G - Milano Fabrics Collection / leather Colorado Col.2560 Cat.2500

Coffee Table Astratto (Cod.T900 x 2)

Top: Printed glass (Cod.VS)
Metal structure: Gunmetal (Cod.50)

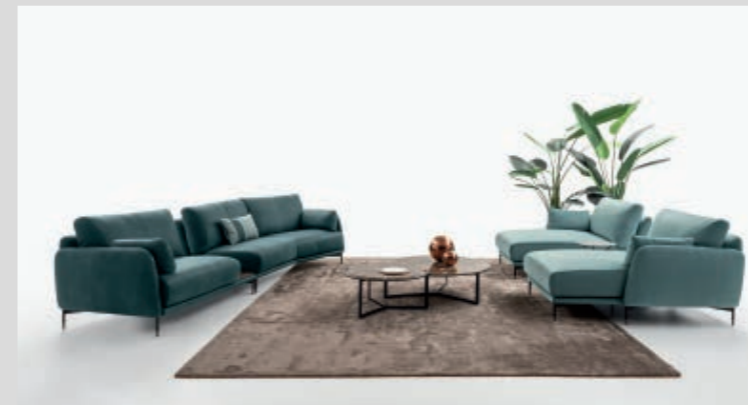

p. 036 / 037

Ghisolfa

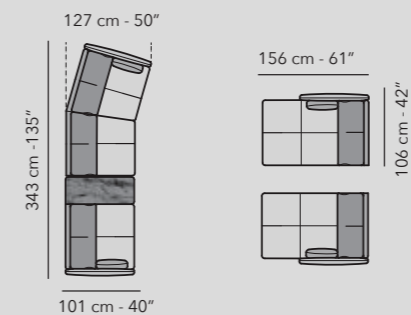

Ghisolfa (Cod.1732+3091+5201+5202)

Pelle: Colorado Col.2560 Cat.2500
Piedi in metallo: Canna di fucile (Cod.50) con parte inferiore verniciata in colore oro satinato

Ghisolfa (Cod.5201+5202)

Tessuto: L1552/EGI Col.26 Cat.G - Collezione Milano Fabrics
Piedi in metallo: Canna di fucile (Cod.50) con parte inferiore verniciata in colore oro satinato

Cuscini:

n°01 Cod.CU73 Rivestimento coordinato: tessuto L1629/LOC Col.05 Cat.G - Collezione Milano Fabrics / pelle Colorado Col.2560 Cat.2500

Tavolino Round (Cod.T907)

Ripiano: marmo Emperador (Cod.EM)
Struttura in metallo: Canna di fucile (Cod.50)

Tavolino Grancircolo (Cod.T902)

Ripiano: marmo Emperador (Cod.EM)
Struttura in metallo: Canna di fucile (Cod.50)

Ghisolfa (Cod.1732+3091+5201+5202)

Leather: Colorado Col.2560 Cat.2500
Metal legs: Gunmetal (Cod.50) with lower part painted in matte gold color

Ghisolfa (Cod.5201+5202)

Fabric: L1552/EGI Col.26 Cat.G - Milano Fabrics Collection
Metal legs: Gunmetal (Cod.50) with lower part painted in matte gold color

Pillows:

Q.ty 01 Cod.CU73 Combined coverings: fabric L1629/LOC Col.05 Cat.G - Milano Fabrics Collection / leather Colorado Col.2560 Cat.2500

Coffee Table Round (Cod.T907)

Top: Emperador marble (Cod.EM)
Metal legs: Gunmetal (Cod.50)

Coffee Table Grancircolo (Cod.T902)

Top: Emperador marble (Cod.EM)
Metal legs: Gunmetal (Cod.50)



p. 020 / 021

Manzoni

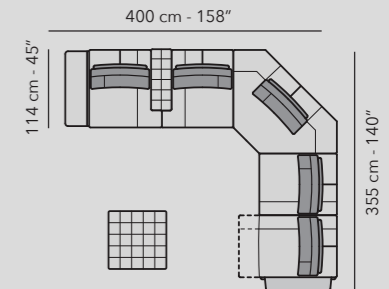

Manzoni (Cod.C1161+1203+4504+1932+8135+C1962+8015)

Pelle: Colorado Col.2550 Cat.2500 - bordino Gros grain Col.91
Piedi in metallo: Canna di fucile (Cod.50)

Manzoni (Cod.C1161)

Bracciolo in cuoio: Verde fango Col.C08

Manzoni (Cod.1932+C1962)

Tessuto: L1534/AVO Col.13 Cat.G - Collezione Milano Fabrics - bordino Gros grain col.91
Piedi in metallo: Canna di fucile (Cod.50)

Manzoni (Cod.C1962)

Terminale in cuoio: Verde fango Col.C08

Manzoni (Cod.8015)

Tessuto: L1552/EGI Col.08 Cat.G - Collezione Milano Fabrics

Cuscini:

n°01 Cod.CU75 Rivestimento coordinato: tessuto L1630/LOH Col.01 Cat.G - Collezione Milano Fabrics / pelle Nabuk Col.5001 Cat.5000
n°01 Cod.CU57 tessuto: L1552/EGI Col.08 Cat.G - Collezione Milano Fabrics
n°01 Cod.CU68 tessuto: L1593/ETA Col.15 Cat.G - Collezione Milano Fabrics

Gioia (Cod.1000)

Mantellina esterna: pelle Nabuk Col.5001 Cat.5000 / Interno: tessuto L1630/LOH Col.01
Cat.G - Collezione Milano Fabrics
Struttura in metallo: Canna di fucile (Cod.50)

Tavolino Metrico (Cod.T905)

Ripiano: marmo Emperador (Cod.EM)
Struttura in metallo: Canna di fucile (Cod.50)

Tavolino Fly Small (Cod.T910)

Struttura in metallo: Bronzo anticato (Cod.52)

Manzoni (Cod.C1201+1203+4504+1932+8135+C1962+8015)

Leather: Colorado Col.2550 Cat.2500 - piping Gros grain Col.91
Metal legs: Gunmetal (Cod.50)

Manzoni (Cod.C1161)

Armrest in hide leather: Mud green Col.C08

Manzoni (Cod.1932+C1962)

Fabric: L1534/AVO Col.13 Cat.G - Milano Fabrics Collection - piping Gros grain Col.91
Metal legs: Gunmetal (Cod.50)

Manzoni (Cod.C1962)

Terminal in hide leather: Mud green Col.C08

Manzoni (Cod.8015)

Fabric: L1552/EGI Col.08 Cat.G - Milano Fabrics Collection

Pillows:

Q.ty 01 Cod.CU75 Combined coverings: fabric L1630/LOH Col.01 Cat.G - Milano Fabrics Collection / leather Nabuk Col.5001 Cat.5000
Q.ty 01 Cod.CU57 fabric: L1552/EGI Col.08 Cat.G - Milano Fabrics Collection
Q.ty 01 Cod.CU68 fabric: L1593/ETA Col.15 Cat.G - Milano Fabrics Collection

Gioia (Cod.1000)

External mantle: pelle Nabuk Col.5001 Cat.5000 / Cushions: fabric L1630/LOH Col.01
Cat.G - Milano Fabrics Collection
Metal structure: Gunmetal (Cod.50)

Coffee Table Metrico (Cod.T905)

Top: Emperador marble (Cod.EM)
Metal structure: Gunmetal (Cod.50)

Coffee Table Fly Small (Cod.T910)

Metal structure: Antique bronze (Cod.52)



p. 026 / 027

Manzoni

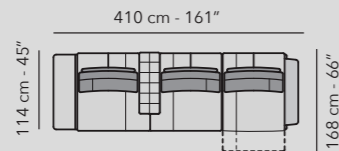

Manzoni (Cod.C1161+1932+8135+C1962)

Manzoni (Cod.C1161)

Pelle: Colorado Col.2550 Cat.2500 - bordino Gros grain Col.91
Piedi in metallo: Canna di fucile (Cod.50)
Bracciolo in cuoio: Verde fango Col.C08

Manzoni (Cod.1932+C1962)

Tessuto: L1534/AVO Col.13 Cat.G - Collezione Milano Fabrics - bordino Gros grain Col.91
Piedi in metallo: Canna di fucile (Cod.50)

Manzoni (Cod.8135)

Pelle: Colorado Col.2550 Cat.2500
Piedi: materiale termoplastico nero

Cuscini:

n°01 Cod.CU75 Rivestimento coordinato: tessuto L1630/LOH Col.01 Cat.G - Collezione Milano Fabrics / pelle Nabuk Col.5001 Cat.5000

Gioia (Cod.1000)

Mantellina esterna: pelle Nabuk Col.5001 Cat.5000 / Interno: fabric L1630/LOH Col.01 Cat.G - Collezione Milano Fabrics
Struttura in metallo: Canna di fucile (Cod.50)

Tavolino Metrico (Cod.T905)

Ripiano: marmo Emperador (Cod.EM)
Struttura in metallo: Canna di fucile (Cod.50)

Tavolino Fly Small (Cod.T910)

Struttura in metallo: Bronzo anticato (Cod.52)

Manzoni (Cod.C1161+1932+8135+C1962)

Manzoni (Cod.C1161)

Leather: Colorado Col.2550 Cat.2500 - piping Gros grain Col.91
Metal legs: Gunmetal (Cod.50)
Armrest in hide leather: Mud green Col.C08

Manzoni (Cod.1932+C1962)

Fabric: L1534/AVO Col.13 Cat.G - Milano Fabrics Collection - piping Gros grain Col.91
Metal legs: Gunmetal (Cod.50)

Manzoni (Cod.8135)

Leather: Colorado Col.2550 Cat.2500
Legs: black thermoplastic material

Pillows:

Q.ty 01 Cod.CU75 Combined coverings: fabric L1630/LOH Col.01 Cat.G - Milano Fabrics Collection / leather Nabuk Col.5001 Cat.5000

Gioia (Cod.1000)

External mantle: leather Nabuk Col.5001 Cat.5000 / Cushions: fabric L1630/LOH Col.01 Cat.G - Milano Fabrics Collection
Metal structure: Gunmetal (Cod.50)

Coffee Table Metrico (Cod.T905)

Top: Emperador marble (Cod.EM)
Metal structure: Gunmetal (Cod.50)

Coffee Table Fly Small (Cod.T910)

Metal structure: Antique bronze (Cod.52)



p. 008 / 009

Nova

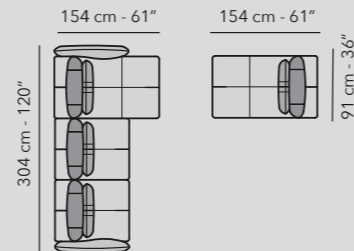

Nova (Cod.3002+5201+5203)

Pelle: Royal Col.2363 Cat.2000 - bordino bracciolo e spalliera in tessuto L1629/LOC Col.01 Cat.G - Collezione Milano Fabrics
Piedi in metallo: Bronzo anticato (Cod.52)
Poggiareni in rivestimento coordinato (CONFIG.N°01): pelle Royal Col.2363 Cat.2000 / tessuto L1629/LOC Col.01 Cat.G - Collezione Milano Fabrics

Pouf Square (Cod.8015)

Tessuto: L1629/LOC Col.01 Cat.G - Collezione Milano Fabrics

Tavolino Decò (Cod.T903)

Ripiano superiore: Cuoio marrone (Cod.CM)
Ripiano inferiore: marmo Emperador (Cod.EM)
Struttura in metallo: Canna di fucile (Cod.50)

Nova (Cod.3002+5201+5203)

Leather: Royal Col.2363 Cat.2000 - Armrest and backrest piping in fabric L1629/LOC Col.01 Cat.G - Milano Fabrics Collection
Metal legs: Antique bronze (Cod.52)
Lumbar cushion combined coverings (CONFIG.01): leather Royal Col.2363 Cat.2000 / fabric L1629/LOC Col.01 Cat.G - Milano Fabrics Collection

Footstool Square (Cod.8015)

Fabric: L1629/LOC Col.01 Cat.G - Milano Fabrics Collection

Coffee Table Decò (Cod.T903)

Upper shelf: Brown hide leather (Cod.CM)
Lower shelf: Emperador marble (Cod.EM)
Metal structure: Gunmetal (Cod.50)



p. 012 / 013

Nova

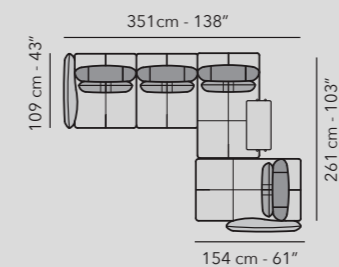

Nova (Cod.3002+5203+5201)

Pelle: Royal Col.2363 Cat.2000 - bordino bracciolo e spalliera in tessuto L1629/LOC Col.01 Cat.G - Collezione Milano Fabrics
Piedi in metallo: Bronzo anticato (Cod.52)
Poggiareni in rivestimento coordinato (CONFIG.N°01): pelle Royal Col.2363 Cat.2000 / tessuto L1629/LOC Col.01 Cat.G - Collezione Milano Fabrics

Pouf Square (Cod.8015)

Tessuto: L1629/LOC Col.01 Cat.G - Collezione Milano Fabrics

Tavolino Decò (Cod.T903)

Ripiano superiore: Cuoio marrone (Cod.CM)
Ripiano inferiore: marmo Emperador (Cod.EM)
Struttura in metallo: Canna di fucile (Cod.50)

Tavolino Shiny (Cod.T908)

Struttura in metallo: Bronzo anticato (Cod.52)

Nova (Cod.3002+5203+5201)

Leather: Royal Col.2363 Cat.2000 - Armrest and backrest piping in fabric L1629/LOC Col.01 Cat.G - Milano Fabrics Collection
Metal legs: Antique bronze (Cod.52)
Lumbar cushion combined coverings (CONFIG.01): leather Royal Col.2363 Cat.2000 / fabric L1629/LOC Col.01 Cat.G - Milano Fabrics Collection

Footstool Square (Cod.8015)

Fabric: L1629/LOC Col.01 Cat.G - Milano Fabrics Collection

Coffee Table Decò (Cod.T903)

Upper shelf: Brown hide leather (Cod.CM)
Lower shelf: Emperador marble (Cod.EM)
Metal structure: Gunmetal (Cod.50)

Coffee Table Shiny (Cod.T908)

Metal structure: Antique bronze (Cod.52)

NOTA: Considerando la specificità dei tessuti utilizzati nelle collezioni Nicoline, rispetto ai salotti con rivestimenti in pelle, la Nicoline potrà senza alcuna comunicazione ridurre e modificare il numero/posizionamento delle cuciture sugli stessi modelli/elementi quando si sceglieranno le soluzioni del rivestimento in tessuto.

NOTE: Taking into consideration the specificity of the fabrics, Nicoline reserves the right to arrange the quantity and location of the seams without communicating it when dealing with the same models and elements in leather coverings.



p. 016 / 017

Nova

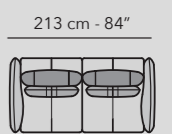

Nova (Cod.3000)

Pelle: Royal Col.2336 Cat.2000 - bordino bracciolo e spalliera in tessuto L1475/KOS Col.06 Cat.D - Collezione Eclettica
Poggiareni in rivestimento coordinato (CONFIG.N°5): pelle Royal Col.2363 Cat.2000 / tessuto L1475/KOS Col.06 Cat.D - Collezione Eclettica
Piedi in metallo: Bronzo anticato (Cod.52)

Tavolino Round (Cod.T907)

Ripiano: marmo bianco Carrara (Cod.CA)
Struttura in metallo: Canna di fucile (Cod.50)

Tavolino Circolo (Cod.T901)

Ripiano: marmo bianco Carrara (Cod.CA)
Struttura in metallo: Canna di fucile (Cod.50)

Nova (Cod.3000)

Leather: Royal Col.2336 Cat.2000 - Armrest and backrest piping in fabric L1475/KOS Col.06 Cat.D - Eclettica Collection
Lumbar cushion combined coverings (CONFIG.5): leather Royal Col.2363 Cat.2000 / fabric L1475/KOS Col.06 Cat.D - Eclettica Collection
Metal legs: Antique bronze (Cod.52)

Coffee Table Round (Cod.T907)

Top: Carrara white marble (Cod.CA)
Metal structure: Gunmetal (Cod.50)

Coffee Table Circolo (Cod.T901)

Top: Carrara white marble (Cod.CA)
Metal structure: Gunmetal (Cod.50)

Coordinated by
Nicoline Marketing Department

Nicoline Salotti S.r.l.

C.da Parchi Calia s.n. – Z.I. Pip 70022 Altamura (Bari) - Italy T +39 080 3101487

info@nicoline.it - www.nicoline.it