

# **nicoline**

I T A L I A

**Home Collection / VOLUME 01**

**BABILA**

**BORA**

**BOVISA**

**BRERA**

**BRESSO**

**BRESSO AIR**

**BRIC**

**CADORNA**

**CAIROLI**

**CAIROLI HIGH**

**CORDUSIO**

**DUOMO**

**ISOLA**

**NAUSICAA**

**TORTONA**

**TURRO**

**ZARA**

**ZARA LIGHT / ZARA CUOIO**





**nicoline**  
LIT & LIA



Babila

p. 130  
/ 143



Bora

p. 168  
/ 179



Bovisa

p. 70  
/ 83



Brera

p. 58  
/ 69



Bresso

p. 180  
/ 189



Bresso Air

p. 190  
/ 197



Bric

p. 216  
/ 225



Cadorna

p. 198  
/ 215





Cairolì

p. 144  
/ 153



Cairolì High

p. 154  
/ 167



Cordusio

p. 238  
/ 247



Duomo

p. 226  
/ 237



Isola

p. 6  
/ 27



Nausicaa

p. 118  
/ 129



Tortona

p. 28  
/ 45



Turro

p. 46  
/ 57



Zara \ Zara Deep

p. 84  
/ 101



Zara Light \  
Zara Light Deep  
Zara Cuoio \  
Zara Cuoio Deep  
p. 102  
/ 117





# Isola



Semplice e confortevole, il divano Isola permette di adattare i moduli a qualsiasi esigenza creando composizioni articolate anche per usi temporanei. Il bracciolo sottile e i complementi in noce canaletto attribuiscono al modello uno stile caratteristico ed intramontabile. Disponibile nella versione pelle, tessuto e mix.

\\

*Simple yet comfortable, the Isola sofa allows you to adapt the modules to your needs by changing their arrangement, even for temporary use. The slim armrest and walnut storage give the model a characteristic, timeless style. Available in leather, fabric or in a combination of the two.*





Isola

Isola









Isola

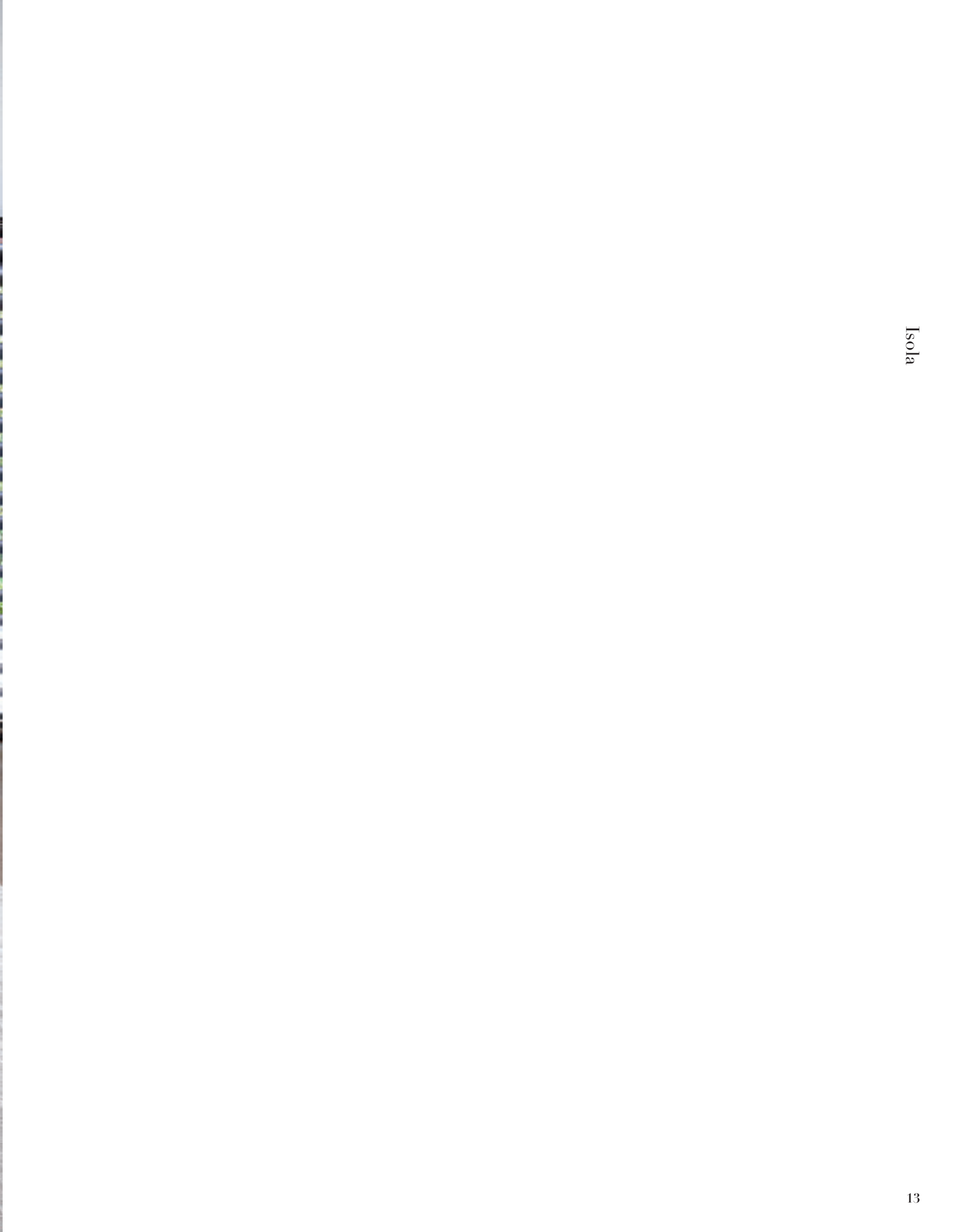

Isola

























Isola



Isola







# Tortona

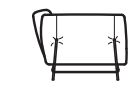

Tortona Living



Tortona Small



Tortona Leg



Opzione \ optional

Dalle curve morbide e confortevoli, il modello Tortona emerge per il suo bracciolo slanciato e leggermente curvato allineato allo schienale. I piedini in finitura canna di fucile con puntale in oro, disponibile in tre stili differenti, conferiscono al modello ulteriore eleganza. Disponibile in pelle e tessuto.

\ \

Featuring soft, comfortable curves, the Tortona model stands out for its slender and slightly, curved armrest aligned with its backrest. The gold-tipped, gunmetal legs, available in three different styles, add a further touch of elegance to this model. Available in leather and fabric.









Tortona Small



Tortona Small











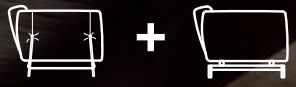

Tortona Living



Tortona Legg





Tortona Living



Tortona Leg





Tortona Leg



Tortona Leg



### Tortona Living



### Tortona Small



### Tortona Leg





# Turro

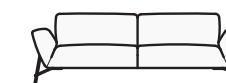

Turro Living



Turro Small



Turro Leg

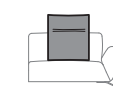

Opzione \ optional

Dalle curve morbide e dall'eccezionale comfort di seduta, il Turro si adatta facilmente alla location classica e moderna a seconda del rivestimento. I piedini in finitura canna di fucile con puntale in oro conferiscono una nota di classe. Disponibile in pelle e tessuto.

\ \

*With its gentle curves and exceptional seating comfort, the Turro adapts easily to classical or modern settings, depending on the upholstery. The gold-tipped gun-metal legs give this model an additional touch of class. Available in leather and fabric.*





Turro Small



Turro Small















### Turro Living



### Turro Small



### Turro Leg





# Brera



**I**mponente, moderno e dotato di meccanismo di movimento per schienale e braccioli, il modello Brera coniuga il design con il comfort. Disponibile in pelle e tessuto.

\ \

*Dominant, modern and equipped with a movement mechanism for the back and armrests, the Brera model combines design with comfort. Available in leather and fabric.*





brea

brea



















# Bovisa



**D**ivano dal design tradizionale facilmente adattabile a qualsiasi ambiente. La presenza di piccoli dettagli, attribuisce al modello Bovisa un'identità unica ed inconfondibile. Disponibile in pelle o tessuto.

\\

*A sofa in a traditional design that easily adapts to any setting. Its subtle detail gives the Bovisa model a unique and unmistakable identity. Available in leather and fabric.*





























### Piedini *Legs*



- |   |             |   |          |
|---|-------------|---|----------|
|  | Shiny Metal |  | Ral 7006 |
|  | Satin Metal |  | Ral 7024 |
|  | Gunmetal    |  | Ral 7044 |
|   |             |  | Ral 8019 |
|   |             |  | Ral 9016 |





# Zara

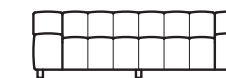

Zara



Zara Deep

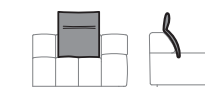

Opzione \ optional

Dal design lineare e pulito, il divano Zara è impreziosito da un inserto centrale in contrasto o in tinta. Nella versione Zara Deep la seduta è più ampia. I due modelli sono componibili tra loro. I piedini laccati nero lucido conferiscono un tocco di eleganza al modello. Disponibile in pelle e tessuto.

\\

With a clean, linear design, the Zara sofa is enriched with a contrasting or matching central insert. The Zara Deep version has a wider seat. Both models can be assembled together. The glossy black-lacquered legs give this model a touch of elegance. Available in leather and fabric.























Tessuto  
Fabric



Cucitura standard per rivestimento in tessuto\\  
Standard stitching for fabric covering

Pelle  
Leather



















Inserto in tessuto RIO solo per rivestimento in pelle\\  
Insert in fabric RIO only for leather upholstery

Pelle  
Leather



Cucitura per pelle NOBILE e con spessore di pelli superiore a 1.8mm, e per tutte le pelli senza inserto\\  
Stitching for NOBILE leather and leathers thicker than 1.8 mm, and for all leathers without insert.

- |  |  |
|--|--|
|  Cod: 100 |  Cod: 603 |
|  Cod: 808 |  Cod: 801 |
|  Cod: 006 |  Cod: 007 |
|  Cod: 610 |  Cod: 717 |
|  Cod: 415 |  Cod: 413 |
|  Cod: 320 |  Cod: 305 |
|  Cod: 010 |  Cod: 809 |
|  Cod: 626 |  Cod: 200 |
|  Cod: 503 |  |











Zara

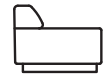

Zara Deep

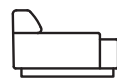

Tutte le versioni dei modelli ZARA - ZARA DEEP - ZARA LIGHT- ZARA LIGHT DEEP - ZARA CUIOIO - ZARA CUIOIO DEEP sono combinabili tra loro  
All versions of ZARA - ZARA DEEP - ZARA LIGHT - ZARA LIGHT DEEP - ZARA CUIOIO (hide leather) - ZARA CUIOIO DEEP (hide leather) can be combined with each other.

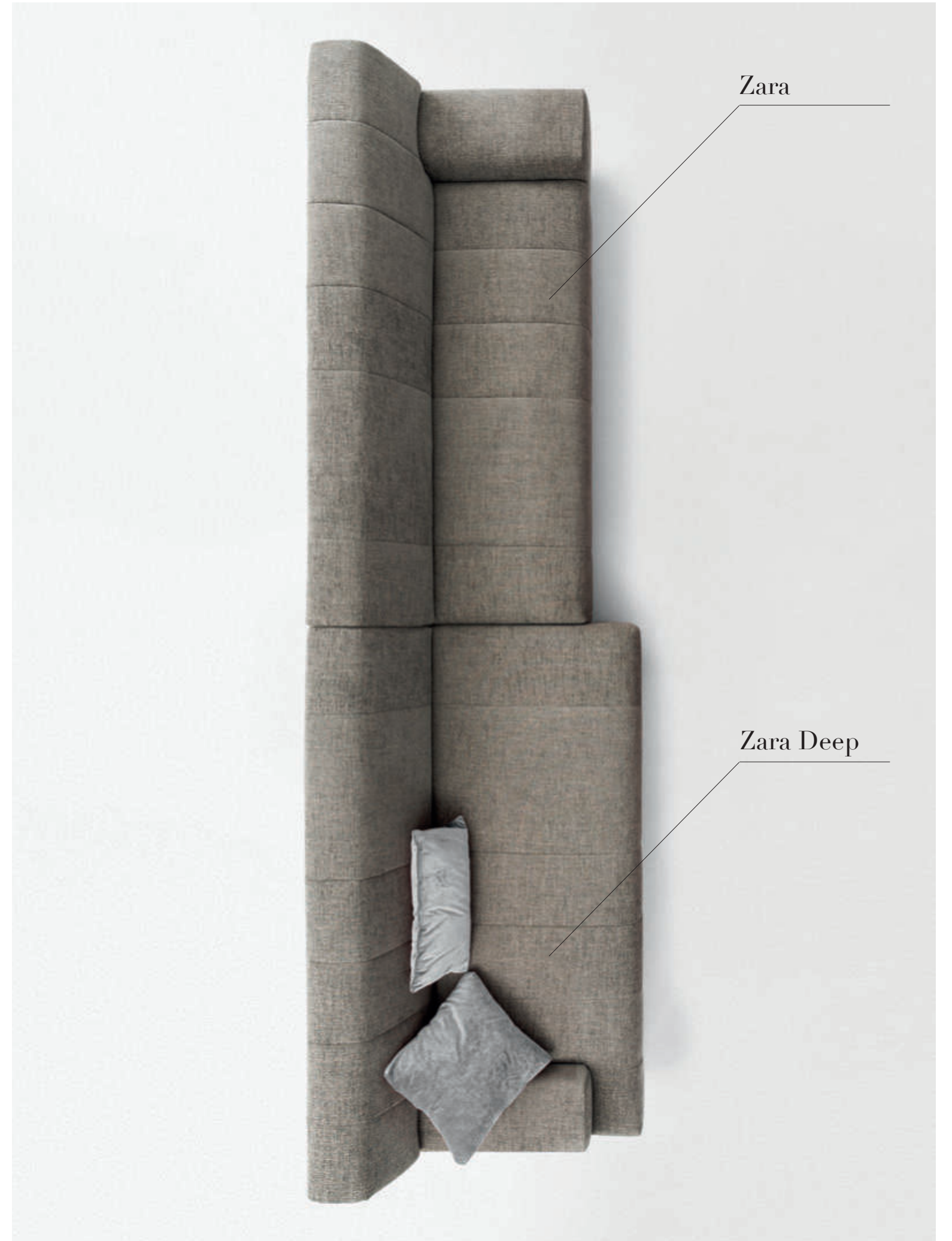

Zara

Zara Deep



# Zara Light

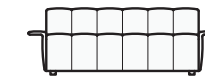

Zara Light



Zara Light Deep

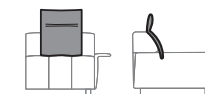

Opzione \ optional

Nato come variante del modello Zara, il modello Zara Light si contraddistingue per il bracciolo sottile in acciaio rivestito in pelle, un dettaglio che lo rende elegante e ricercato. Disponibile in pelle e tessuto.

\ \

Conceived as a variant of the Zara, the Zara Light stands out for its slim, steel, leather-upholstered armrest which gives it an elegant, refined style. Available in leather and fabric.





Zara Light

Zara Light







Zara Light



Zara Light





Zara Light



Zara Light







Zara Light



Zara Light





Zara Cuoio

Zara Cuoio









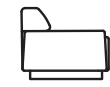

Zara Light



Zara Light Deep

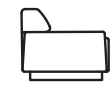

Zara Cuoio



Zara Cuoio Deep



Tutte le versioni dei modelli ZARA - ZARA DEEP - ZARA LIGHT- ZARA LIGHT DEEP - ZARA CUIOIO - ZARA CUIOIO DEEP sono combinabili tra loro  
All versions of ZARA - ZARA DEEP - ZARA LIGHT - ZARA LIGHT DEEP - ZARA CUIOIO (hide leather) - ZARA CUIOIO DEEP (hide leather) can be combined with each other.



# Nausicaa



**S**emplice, lineare, raffinato. Nausicaa è un modello che si adatta ad ogni tipo di ambiente. Versatile e dinamico, si presta a diverse composizioni. Un elegante bordino traccia i contorni e ne esalta le forme. Disponibile in pelle o tessuto.

∥

*Simple, linear, refined. The Nausicaa model can be adapted to any kind of environment. Versatile and dynamic, it lends itself to different arrangements. An elegant border outlines the contours and enhances its shapes. Available in leather and fabric.*



















Piedini  
*Legs*



- Shiny Metal
- Satin Metal
- Gunmetal





# Babila



Perfetto per qualsiasi ambiente, il divano Babila presenta una struttura rigida, interrotta dalle linee morbide di schienali e poggiatesta leggermente inclinati. Disponibile in pelle o tessuto.

\\

*Perfect in any setting, the Babila sofa has a rigid structure, interrupted by the soft lines of its slightly inclined back cushions and headrests. Available in leather and fabric.*































Piedini  
*Legs*



- |   |             |   |          |
|---|-------------|---|----------|
|  | Shiny Metal |  | Ral 7006 |
|  | Satin Metal |  | Ral 7024 |
|  | Gunmetal    |  | Ral 7044 |
|   |             |  | Ral 8019 |
|   |             |  | Ral 9016 |





# Cairolì

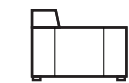
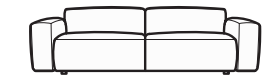

Cairolì



Cairolì Deep

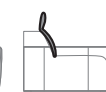

Opzione \ optional

Voluminoso, imponente, compatto. Il Cairolì è un divano progettato per ambienti spaziosi e moderni. Si caratterizza per i moduli che sembrano sfiorare il pian terreno. Disponibile in pelle o tessuto.

\\

*Voluminous, dominant, compact. The Cairolì is a sofa designed for modern, spacious settings. It stands out for its modules slightly touching the surface of the floor.*



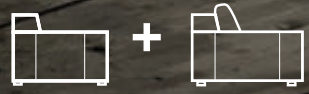

Cairoli Cairoli Deep



Cairoli Cairoli Deep





**N**ella versione Cairoli Deep, la seduta è più profonda e garantisce un comfort assoluto. Disponibile in pelle o tessuto.

∞

*In the Deep version of the Cairoli, the seat is deeper and guarantees absolute comfort. Available in leather and fabric.*









Bracciolo Cairolì

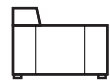

Tutte le versioni dei modelli CAIROLÌ - CAIROLÌ DEEP - CAIROLÌ HIGH - CAIROLÌ HIGH DEEP sono combinabili tra loro  
All versions of CAIROLÌ - CAIROLÌ DEEP - CAIROLÌ HIGH - CAIROLÌ HIGH DEEP can be combined with each other.

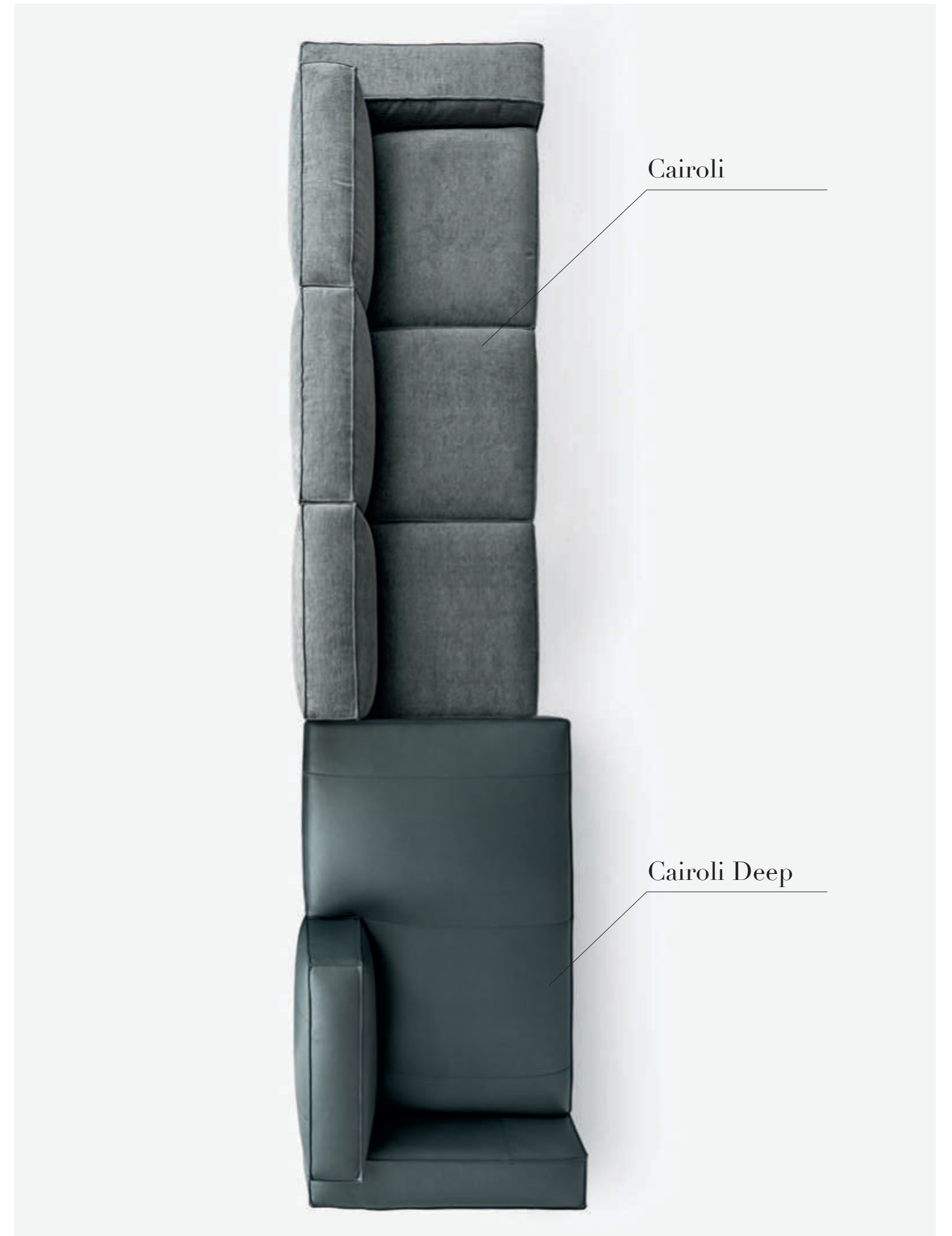

Cairolì

Cairolì Deep



# Cairolì High

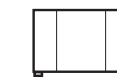
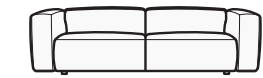

Cairolì High



Cairolì High Deep

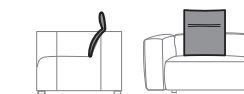

Opzione \ optional

**N**ella versione Cairoli High, bracciolo e schienale hanno la stessa altezza.

∥

*In the High version of Cairoli, the armrest and backrest have the same height.*





Cairoli High



Cairoli High



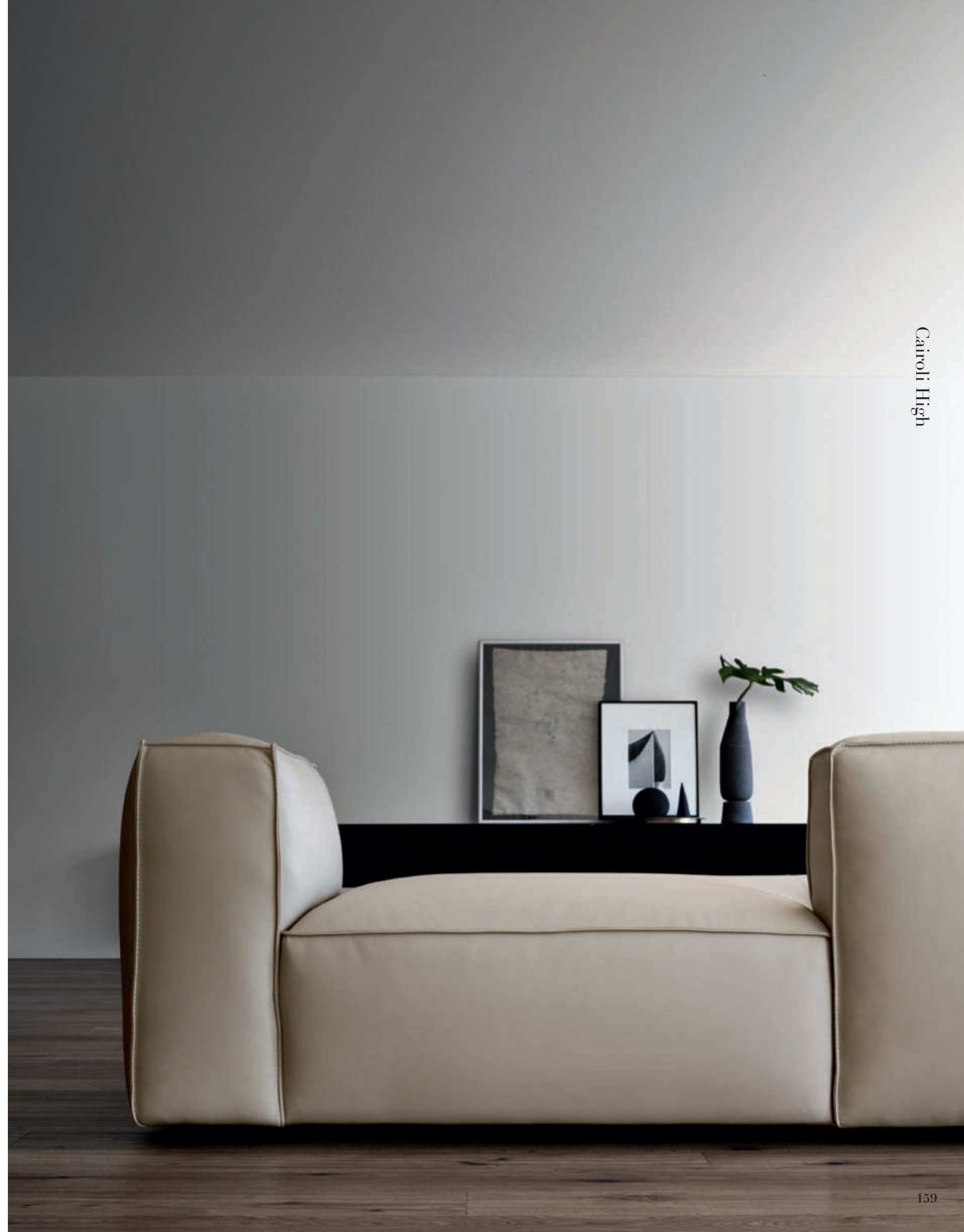
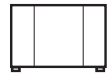





Cairoli High



Cairoli High



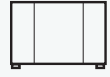





Cairoli High\Cairoli High Deep



Cairoli High\Cairoli High Deep





Tutte le versioni dei modelli CAIROLI - CAIROLI DEEP - CAIROLI HIGH - CAIROLI HIGH DEEP sono combinabili tra loro  
All versions of CAIROLI - CAIROLI DEEP - CAIROLI HIGH - CAIROLI HIGH DEEP can be combined with each other.





# Bora



Versatile e dalle forme lineari e pulite, il modello Bora è il perfetto connubio tra comfort ed eleganza. Disponibile in pelle o tessuto.

\\

Versatile, with linear and clean forms, the Bora model perfectly combines comfort with elegance. Available in leather and fabric.





Bora

Bora



Bora



Bora











Piedini  
*Legs*



Shiny  
Metal



Satin  
Metal



Gunmetal





# Bresso

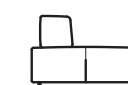
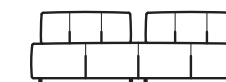

Bresso

Gli schienali mobili, ma al tempo stesso stabili, conferiscono al modello Bresso un design dinamico consentendo di comporre il divano a proprio piacimento. Disponibile in pelle, tessuto o nella versione mix.

\\

*The movable yet stable backrests lend the Bresso model a dynamic design that allows you to arrange the sofa as you please. Available in leather, fabric or in a combination of the two.*





Bresso

Bresso





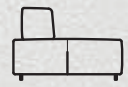

Bresso



Bresso





Bresso



Bresso





Tutte le versioni dei modelli BRESSO - BRESSO AIR sono combinabili tra loro  
All versions of BRESSO - BRESSO AIR can be combined with each other.



# Bresso Air

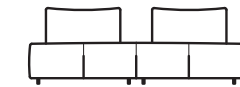

Bresso Air

Nella versione Bresso Air gli schienali sembrano ripiegati su se stessi. Disponibile in pelle, tessuto o nella versione mix.

\\

*In the Bresso "Air" version, the backrests seem to be folded down on themselves. Available in leather, fabric or in a combination of the two.*



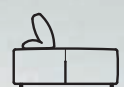

Bresso Air

Bresso Air





Bresso Air



Bresso Air





Tutte le versioni dei modelli BRESSO - BRESSO AIR sono combinabili tra loro  
*All versions of BRESSO - BRESSO AIR can be combined with each other.*



# Cadorna



Sedute e schienali imponenti e braccioli dall'effetto morbido e scomposto sono abbracciati da una struttura geometrica e lineare, conferendo al Cadorna una sensazione di avvolgente relax. Disponibile nella versione pelle o tessuto.

∥

*The dominant seats and backrest, the armrests with a soft, shabby-chic effect are framed within a linear, geometric structure, giving the Cadorna a feeling of enchanting relaxation. Available in leather and fabric.*













Cadorna

Cadorna























Piedini  
*Legs*



- |   |  |
|---|--|
|  Shiny Metal |  Ral 7006 |
|  Satin Metal |  Ral 7024 |
|  Gunmetal    |  Ral 7044 |
|  Satin Brass |  Ral 8019 |
|   |  Ral 9016 |





# Bric



Semplice e geometrico, il modello Bric è ideale in ambienti moderni. I disegni verticali creati dalle cuciture artigianali lo rendono unico ed originale. Disponibile in pelle o tessuto.

\\

*The simple, geometric style of the Bric makes it the ideal model for a modern environment. The vertical design of the stitching makes it a unique and original piece. Available in leather and fabric.*



















# Duomo



**I**l modello Duomo richiama il più classico divano in stile capitonné. La tipica lavorazione artigianale si estende anche alla seduta monoblocco conferendogli classe ed eleganza. I piedini in finitura metallica slanciano e rendono ideale il divano anche in ambienti in stile moderno. Disponibile in pelle o tessuto.

\\

*The Duomo model recalls the most classical capitonné-style sofas. The high craftsmanship extends to the single-block seat, emphasizing its classy and elegant style. The delicate metallic legs also make this sofa ideal for any modern setting. Available in leather and fabric.*



















Piedini  
*Legs*



- Shiny Metal
- Satin Metal
- Gunmetal





# Cordusio



Cordusio è il modello che ridefinisce l'estetica del classico divano in stile capitonné. La seduta a blocco unico rende il design contemporaneo e ne mitiga il classico e rigoroso aspetto. I piedini metallici lo slanciano e gli conferiscono stile ed eleganza. Disponibile in pelle o tessuto.

∥

*The Cordusio model recalls the aesthetics of the classical capitonné-style sofa. The single-block seat gives it a contemporary look and mitigates its rigorous, classical appearance. The metallic legs empower its delicate and elegant style. Available in leather and fabric.*















Piedini  
*Legs*



- Shiny Metal
- Satin Metal
- Gunmetal











p. 130 / 131

## Babila

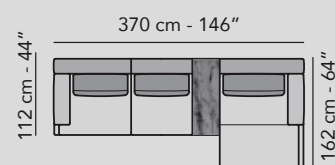

**Babila (Cod.3032+5201)**  
Tessuto: L1569/OLO Col.02 Cat.G - Collezione Florence  
Piedi: metallo Canna di fucile (Cod.50)

**Cuscini**  
n°02 Cod.CU58 tessuto: L1569/OLO Col.20 Cat.G - Collezione Florence

**Tavolino Round (Cod.T907)**  
Ripiano: marmo Emperador (Cod.EM)  
Struttura: metallo Canna di fucile (Cod.50)

**Tavolino Circolo (Cod.T901)**  
Ripiano: marmo Emperador (Cod.EM)  
Struttura: metallo Canna di fucile (Cod.50)

**Babila (Cod.3032+5201)**  
Fabric: L1569/OLO Col.02 Cat.G - Florence Collection  
Metal legs: Gunmetal (Cod.50)

**Pillows:**  
Q.ty 02 Cod.CU58 fabric: L1569/OLO Col.20 Cat.G - Florence Collection

**Coffee Table Round (Cod.T907)**  
Top: Emperador marble (Cod.EM)  
Metal structure: Gunmetal (Cod.50)

**Coffee Table Circolo (Cod.T901)**  
Top: Emperador marble (Cod.EM)  
Metal structure: Gunmetal (Cod.50)



p. 174 / 175

## Bora

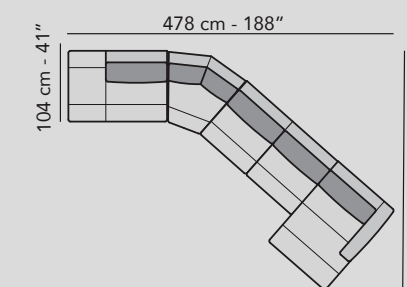

**Bora (Cod.1602+4015+3003+5201+8027 x 2)**  
Tessuto: VEG Col.45 Cat.G - Collezione Florence  
Piedi: metallo Canna di fucile (Cod.50)  
**Bora (Cod.8027)**  
Tessuto: L1569/OLO Col.20 Cat.G - Collezione Florence  
Piedi: metallo Canna di fucile (Cod.50)

**Cuscini:**  
n°01 Cod.CU68 tessuto: VEG Col.53 Cat.G - Collezione Florence  
n°01 Cod.CU68 tessuto: L1569/OLO Col.20 Cat.G - Collezione Florence  
n°01 Cod.CU57 tessuto: L1569/OLO Col.20 Cat.G - Collezione Florence  
n°01 Cod.CU58 tessuto: L1569/OLO Col.20 Cat.G - Collezione Florence

**Tavolino Plane (Cod.T911)**  
Ripiano: legno Noce canaletto (Cod.10)  
Struttura: metallo Canna di fucile (Cod.50)

**Bora (Cod.1602+4015+3003+5201+8027 x 2)**  
Fabric: VEG Col.45 Cat.G - Florence Collection  
Metal legs: Gunmetal (Cod.50)  
**Bora (Cod.8027)**  
Fabric: L1569/OLO Col.20 Cat.G - Florence Collection  
Metal legs: Gunmetal (Cod.50)

**Pillows:**  
Q.ty 01 Cod.CU68 fabric: VEG Col.53 Cat.G - Florence Collection  
Q.ty 01 Cod.CU68 fabric: L1569/OLO Col.20 Cat.G - Florence Collection  
Q.ty 01 Cod.CU57 fabric: L1569/OLO Col.20 Cat.G - Florence Collection  
Q.ty 01 Cod.CU58 fabric: L1569/OLO Col.20 Cat.G - Florence Collection

**Coffee Table Plane (Cod.T911)**  
Top: wood in Canaletto walnut (Cod.10)  
Metal structure: Gunmetal (Cod.50)



p. 170 / 171

## Bora

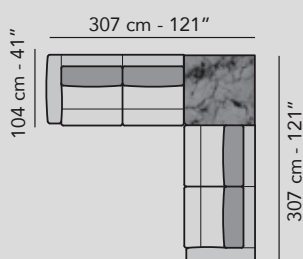

**Bora (Cod.3002+8091+3001)**  
Pelle: Colorado Col.2551 Cat.2500  
Piedi: metallo Canna di fucile (Cod.50)  
**Bora (Cod.8091)**  
Pelle: Colorado Col.2551 Cat.2500  
Ripiano: marmo Emperador (Cod.EM)  
Piedi: metallo Canna di fucile (Cod.50)

**Cuscini:**  
n°01 Cod.CU68 tessuto: L1597/TRA Col.06 Cat.G - Collezione Florence  
n°01 Cod.CU58 tessuto: L1597/TRA Col.06 Cat.G - Collezione Florence  
n°01 Cod.CU58 tessuto: L1569/OLO Col.20 Cat.G - Collezione Florence

**Ghirla (Cod.1000)** - Scocca: tessuto VEG Col.45 Cat.G - Collezione Florence  
- Cuscini di seduta/spalliera: tessuto L1597/TRA Col.06 Cat.G - Collezione Florence  
- Base: legno verniciato Wengè (Cod.05)

**Bora (Cod.3002+8091+3001)**  
Leather: Colorado Col.2551 Cat.2500  
Metal legs: Gunmetal (Cod.50)  
**Bora (Cod.8091)**  
Leather: Colorado Col.2551 Cat.2500  
Top: Emperador marble (Cod.EM)  
Metal legs: Gunmetal (Cod.50)

**Pillows:**  
Q.ty 01 Cod.CU68 fabric: L1597/TRA Col.06 Cat.G - Florence Collection  
Q.ty 01 Cod.CU58 fabric: L1597/TRA Col.06 Cat.G - Florence Collection  
Q.ty 01 Cod.CU58 fabric: L1569/OLO Col.20 Cat.G - Florence Collection

**Ghirla (Cod.1000)** Frame: fabric VEG Col.45 Cat.G - Florence Collection -  
Seat and back cushions: fabric L1597/TRA Col.06 Cat.G - Florence Collection  
- Base: wood painted in Wengè (Cod.05)



p. 072 / 073

## Bovisa

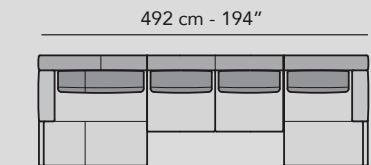

**Bovisa (Cod.5232+3203+5201)**  
Pelle: Nabuk Col.5001 Cat.5000  
Piedi: metallo Canna di fucile (Cod.50)

**Cuscini:**  
n°02 Cod.CU68 tessuto: VEG Col.74 Cat.G - Collezione Florence  
n°02 Cod.CU58 tessuto: L1575/TOD Col.01 Cat.G - Collezione Florence

**Lima (Cod.1000 x 2)**  
Tessuto: VEG Col.74 Cat.G - Collezione Florence  
Struttura: metallo Bronzo anticato (Cod.52)

**Bovisa (Cod.5232+3203+5201)**  
Leather: Nabuk Col.5001 Cat.5000  
Metal legs: Gunmetal (Cod.50)

**Pillows:**  
Q.ty 02 Cod.CU68 fabric: VEG Col.74 Cat.G - Florence Collection  
Q.ty 02 Cod.CU58 fabric: L1575/TOD Col.01 Cat.G - Florence Collection

**Lima (Cod.1000 x 2)**  
Fabric: VEG Col.74 Cat.G - Florence Collection  
Metal structure: Antique bronze (Cod.52)





p. 080 / 081

## Bovisa

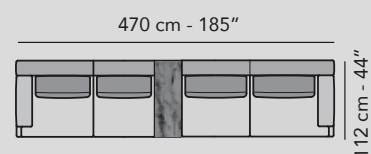

### Bovisa (Cod.3032+3201)

Tessuto: L1459/MIL Col.01 Cat.D - Collezione Eclettica  
Piedi: metallo Canna di fucile (Cod.50)

### Cuscini:

n°02 Cod.CU68 tessuto: VEG Col.74 Cat.G - Collezione Florence  
n°01 Cod.CU58 tessuto: L1575/TOD Col.01 Cat.G - Collezione Florence

### Ghirla (Cod.1000)

Scocca: pelle Arizona Col.4088 Cat.4000  
Cuscini di seduta/spalliera: tessuto L1459/MIL Col.02 Cat.D - Coll. Eclettica  
Base: legno verniciato Wengè (Cod.05)

### Tavolino Metrico (Cod.T905)

Ripiano: marmo Emperador (Cod.EM)  
Struttura: metallo Canna di fucile (Cod.50)

### Tavolino Fly (Cod.T909)

Struttura: metallo Bronzo anticato (Cod.52)

### Bovisa (Cod.3032+3201)

Fabric: L1459/MIL Col.01 Cat.D - Eclettica Collection  
Metal legs: Gunmetal (Cod.50)

### Pillows:

Q.ty 02 Cod.CU68 fabric: VEG Col.74 Cat.G - Florence Collection  
Q.ty 01 Cod.CU58 fabric: L1575/TOD Col.01 Cat.G - Florence Collection

### Ghirla (Cod.1000)

Frame: leather Arizona Col.4088 Cat.4000  
Seat and back cushions: fabric L1459/MIL Col.02 Cat.D - Eclettica Collection  
Base: wood painted in Wengè (Cod.05)

### Coffee Table Metrico (Cod.T905)

Top: Emperador marble (Cod.EM)  
Metal structure: Gunmetal (Cod.50)

### Coffee Table Fly (Cod.T909)

Metal structure: Antique Bronze (Cod.52)



p. 078

## Bovisa

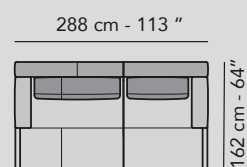

### Bovisa (Cod.5232+5201)

Pelle: Nabuk Col.5001 Cat.5000  
Piedi: metallo Canna di fucile (Cod.50)

### Cuscini:

n°01 Cod.CU 58 tessuto: VEG Col.45 Cat.G-Collezione Florence

### Tavolino Shiny ( T908)

Struttura in metallo Bronzo anticato ( cod.52)

### Bovisa (Cod.5232+5201)

Leather: Nabuk Col.5001 Cat.5000  
Metal legs: Gunmetal (Cod.50)

### Pillows:

Q.ty 01 Cod.CU 58 fabric: VEG Col. 45 Cat.G - Florence Collection

### Coffee Table Shiny (Cod. T908)

Metal structure: Antique bronze (Cod.52)



p. 060 / 061

## Brera

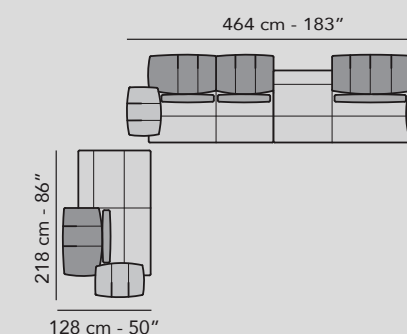

### Brera (Cod.3002+3231)

Tessuto: L1569/OLO Col.02 Cat.G - Collezione Florence  
Piedi: metallo Canna di fucile (Cod.50)

### Cuscini

n°01 Cod.CU57 tessuto: VEG Col.52 Cat.G - Collezione Florence  
n°01 Cod.CU57 tessuto: L 1598/MOZ Col.04 Cat.G - Collezione Florence

### Brera (Cod.3022)

Tessuto: VEG Col.52 Cat.G - Collezione Florence  
Piedi: metallo Canna di fucile (Cod.50)

### Tavolino Metrico (Cod.T905)

**Tavolino Grancircolo (Cod.T902)**  
Ripiano: marmo Emperador (Cod.EM)  
Struttura metallo: Canna di fucile (Cod.50)

### Tavolino Plane (Cod.T911)

Ripiano: legno Noce canaletto (Cod.10)  
Struttura: metallo Bronzo anticato (Cod.52)

### Brera (Cod.3002+3231)

Fabric: L1569/OLO Col.02 Cat.G - Florence Collection  
Metal legs: Gunmetal (Cod.50)

### Pillows

Q.ty 01 Cod.CU57 fabric: VEG Col.52 Cat.G - Florence Collection  
Q.ty 01 Cod.CU57 fabric: L 1598/MOZ Col.04 Cat.G - Florence Collection

### Brera (Cod.3022)

Fabric: VEG Col.52 Cat.G  
Metal legs: Gunmetal (Cod.50)

### Coffee Table Metrico (Cod.T905)

**Coffee Table Grancircolo (Cod.T902)**  
Top: Emperador marble (Cod.EM)  
Metal structure: Gunmetal (Cod.50)

### Coffee Table Plane (Cod.T911)

Top: wood in Canaletto walnut (Cod.10)  
Metal structure: Antique Bronze (Cod.52)



p. 064 / 065

## Brera

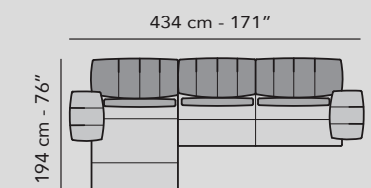

### Brera (Cod.5202+3201)

Pelle: Arizona Col.4084 Cat.4000  
Piedi: metallo Canna di fucile (Cod.50)

### Tavolino Metrico (Cod.T905)

Ripiano: marmo Emperador (Cod.EM)  
Struttura: metallo Canna di fucile (Cod.50)

### Tavolino Circolo (Cod.T901)

Ripiano: marmo Emperador (Cod.EM)  
Struttura: metallo Canna di fucile (Cod.50)

### Brera (Cod.5202+3201)

Leather: Arizona Col.4084 Cat.4000  
Metal legs: Gunmetal (Cod.50)

### Coffee Table Metrico (Cod.T905)

Top: Emperador marble (Cod.EM)  
Metal structure: Gunmetal (Cod.50)

### Coffee Table Circolo (Cod.T901)

Top: Emperador marble (Cod.EM)  
Metal structure: Gunmetal (Cod.50)





p. 068 / 069

## Brera

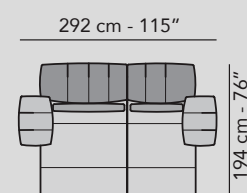

**Brera (Cod.5202+5001)**  
 Pelle: Arizona Col.4080 Cat.4000  
 Piedi: metallo Canna di fucile (Cod.50)

**Cuscini:**  
 n°01 Cod.CU57 tessuto: VEG Col.34 Cat.G - Collezione Florence

**Tavolino Plane (Cod.T911)**  
 Ripiano: legno Noce canaletto (Cod.10)  
 Struttura: metallo Bronzo anticato (Cod.52)

**Brera (Cod.5202+5001)**  
 Leather: Arizona Col.4080 Cat.4000  
 Metal legs: Gunmetal (Cod.50)

**Pillows:**  
 Q.ty 01 Cod.CU57 fabric: VEG Col.34 Cat.G - Florence Collection

**Coffee Table Plane (Cod.T911)**  
 Top: wood in Canaletto walnut (Cod.10)  
 Metal structure: Antique bronze (Cod.52)



p. 184 / 185

## Bresso

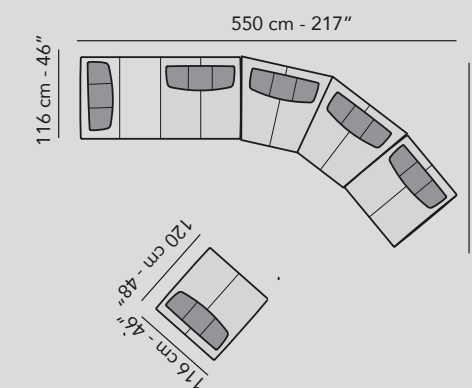

**Bresso (Cod.3203+4015+4015+1203+1203)**  
 Tessuto: L1542/MAK Col.05 Cat.D - Collezione Eclettica  
 Schienali mix: retro in pelle Princess Col.3527 Cat.3500 /  
 Avanti in tessuto L1542/MAK Col.05 Cat.D - Collezione Eclettica  
 Piedi: metallo Canna di fucile (Cod.50)

**Cuscini:**  
 n°01 Cod.CU57 pelle: Princess Col.3527 Cat.3500  
 n°01 Cod.CU57 tessuto: L1542/MAK Col.05 Cat.D - Collezione Eclettica  
 n°01 Cod.CU68 pelle: Princess Col.3527 Cat.3500  
 n°01 Cod.CU68 tessuto: L1542/MAK Col.05 Cat.D - Collezione Eclettica

**Tavolino Deco' Small (Cod.T904)**  
 Ripiano superiore: Cuoio marrone (Cod.CM)  
 Ripiano inferiore: marmo Emperador (Cod.EM)  
 Struttura: metallo Canna di fucile (Cod.50)

**Tavolino Fly (Cod.T909)**  
**Tavolino Fly Small (Cod.T910)**  
 Struttura: metallo Bronzo anticato (Cod.52)

**Bresso (Cod.3203+4015+4015+1203+1203)**  
 Fabric: L1542/MAK Col.05 Cat.D - Eclettica Collection  
 Back cushions mix: back part in leather Princess Col.3527 Cat.3500 /  
 Frontal part in fabric L1542/MAK Col.05 Cat.D - Eclettica Collection  
 Metal legs: Gunmetal (Cod.50)

**Pillows:**  
 Q.ty 01 Cod.CU57 leather: Princess Col.3527 Cat.3500  
 Q.ty 01 Cod.CU57 fabric: L1542/MAK Col.05 Cat.D - Eclettica Collection  
 Q.ty 01 Cod.CU68 leather: Princess Col.3527 Cat.3500  
 Q.ty 01 Cod.CU68 fabric: L1542/MAK Col.05 Cat.D - Eclettica Collection

**Coffee Table Deco' Small (Cod.T904)**  
 Upper shelf: Brown leather (Cod.CM)  
 Lower shelf: Emperador marble (Cod.EM)  
 Metal structure: Gunmetal (Cod.50)

**Coffee Table Fly (Cod.T909)**  
**Coffee Table Fly Small (Cod.T910)**  
 Metal structure: Antique bronze (Cod.52)



p. 182 / 183

## Bresso

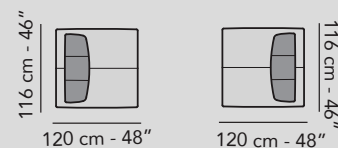

**Bresso (Cod.1203+1203)**  
 Tessuto: L1542/MAK Col.05 Cat.D - Collezione Eclettica  
 Schienali mix: retro in pelle Princess Col.3527 Cat.3500  
 Avanti in tessuto L1542/MAK Col.05 Cat.D - Collezione Eclettica  
 Piedi: metallo Canna di fucile (Cod.50)

**Cuscini:**  
 n°01 Cod.CU72 pelle: Princess Col.3527 Cat.3500  
 n°01 Cod.CU68 pelle: Princess Col.3527 Cat.3500

**Tavolino Grancircolo (Cod.T902)**  
 Ripiano: marmo Emperador (Cod.EM)  
 Struttura: metallo Canna di fucile (Cod.50)

**Tavolino Circolo (Cod.T901)**  
 Ripiano: marmo Emperador (Cod.EM)  
 Struttura: metallo Canna di fucile (Cod.50)

**Bresso (Cod.1203+1203)**  
 Fabric: L1542/MAK Col.05 Cat.D - Eclettica Collection  
 Back cushions mix: back part in leather Princess Col.3527 Cat.3500  
 Frontal part in fabric L1542/MAK Col.05 Cat.D - Eclettica Collection  
 Metal legs: Gunmetal (Cod.50)

**Pillows:**  
 Q.ty 01 Cod.CU72 leather: Princess Col.3527 Cat.3500  
 Q.ty 01 Cod.CU68 leather: Princess Col.3527 Cat.3500

**Coffee Table Grancircolo (Cod.T902)**  
 Top: Emperador marble (Cod.EM)  
 Metal structure: Gunmetal (Cod.50)

**Coffee Table Circolo (Cod.T901)**  
 Top: Emperador marble (Cod.EM)  
 Metal structure: Gunmetal (Cod.50)



p. 186 / 187

## Bresso

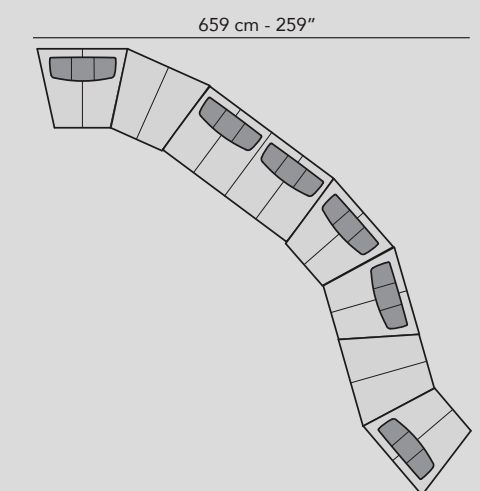

**Bresso (Cod.4015+8100+ 3203+4015+4015+8100+4015...)**  
 Tessuto: L1542/MAK Col.05 Cat.D - Collezione Eclettica  
 Schienali mix: Retro in pelle Princess Col.3526 Cat.3500 /  
 Avanti in tessuto L1542/MAK Col.05 Cat.D - Collezione Eclettica  
 Piedi: metallo Canna di fucile (Cod.50)

**Cuscini:**  
 n°01 Cod.CU68 pelle: Princess Col.3526 Cat.3500

**Bresso (Cod.4015+8100+ 3203+4015+4015+8100+4015...)**  
 Fabric: L1542/MAK Col.05 Cat.D - Eclettica Collection  
 Back cushions mix: back part in leather Princess Col.3526 Cat.3500 /  
 Frontal part in fabric L1542/MAK Col.05 Cat.D - Eclettica Collection  
 Metal legs: Gunmetal (Cod.50)

**Pillows:**  
 Q.ty 01 Cod.CU68 leather: Princess Col.3526 Cat.3500





p. 188

## Bresso

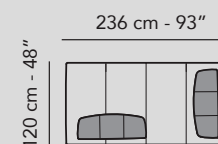

**Bresso (Cod.3203)**  
Tessuto: L1542/MAK Col.05 Cat.D - Collezione Eclettica  
Piedi: metallo Canna di fucile (Cod.50)

**Cuscini:**  
n°01 Cod.CU68 pelle: Princess Col.3526 Cat.3500

**Tavolino Decò (Cod.T903)**  
Ripiano superiore: Cuoio marrone (Cod.CM)  
Ripiano inferiore: marmo Emperador (Cod.EM)  
Struttura: metallo Canna di fucile (Cod.50)

**Bresso (Cod.3203)**  
Fabric: L1542/MAK Col.05 Cat.D  
Metal legs: Gunmetal (Cod.50)

**Pillows:**  
Q.ty 01 Cod.CU68 leather: Princess Col.3526 Cat.3500

**Coffee Table Deco' (Cod.T903)**  
Upper shelf: Brown leather (Cod.CM)  
Lower shelf: Emperador marble (Cod.EM)  
Metal structure: Gunmetal (Cod.50)



p. 192 / 193

## Bresso Air

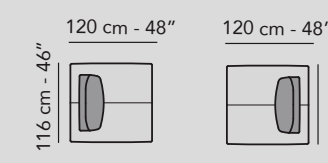

**Bresso Air (Cod.1203+1203)**  
Tessuto: L1542/MAK Col.05 Cat.D - Collezione Eclettica  
Piedi: metallo Canna di fucile (Cod.50)

**Cuscini:**  
n°01 Cod.CU72 pelle: Princess Col.3527 Cat.3500  
n°01 Cod.CU68 pelle: Princess Col.3527 Cat.3500

**Tavolino Grancircolo (Cod.T902)**  
Ripiano: marmo Emperador (Cod.EM)  
Struttura: metallo Canna di fucile (Cod.50)

**Tavolino Circolo (Cod.T901)**  
Ripiano: marmo Emperador (Cod.EM)  
Struttura: metallo Canna di fucile (Cod.50)

**Bresso Air (Cod.1203+1203)**  
Fabric: L1542/MAK Col.05 Cat.D - Eclettica Collection  
Metal legs: Gunmetal (Cod.50)

**Pillows:**  
Q.ty 01 Cod.CU72 leather: Princess Col.3527 Cat.3500  
Q.ty 01 Cod.CU68 leather: Princess Col.3527 Cat.3500

**Coffee Table Grancircolo (Cod.T902)**  
Top: Emperador marble (Cod.EM)  
Metal structure: Gunmetal (Cod.50)

**Coffee Table Circolo (Cod.T901)**  
Top: Emperador marble (Cod.EM)  
Metal structure: Gunmetal (Cod.50)



p. 190 / 191

## Bresso Air

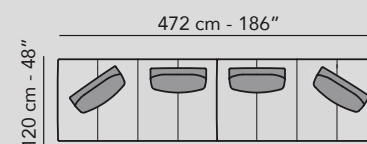

**Bresso Air (Cod.3203+3203)**  
Seduta: tessuto DAM Col.16 Cat.D - Collezione Eclettica  
Schienali: tessuto L1542/MAK Col.05 Cat.D - Collezione Eclettica  
Piedi: metallo Canna di fucile (Cod.50)

**Cuscini:**  
n°01 Cod.CU58 pelle: Princess Col.3527 Cat.3500  
n°01 Cod.CU68 pelle: Princess Col.3527 Cat.3500  
n°01 Cod.CU57 pelle: Princess Col.3527 Cat.3500

**Tavolino Plane (Cod.T911)**  
Ripiano: legno Noce canaletto (Cod.10)  
Struttura: metallo Bronzo anticato (Cod.52)

**Tavolino Fly (Cod.T909)**  
Struttura: metallo Bronzo anticato (Cod.52)

**Tavolino Fly Small (Cod.T910)**  
Struttura: metallo Bronzo anticato (Cod.52)

**Bresso Air (Cod.3203+3203)**  
Seat cushions: fabric DAM Col.16 Cat.D - Eclettica Collection  
Back cushions: fabric L1542/MAK Col.05 Cat.D - Eclettica Collection  
Metal legs: Gunmetal (Cod.50)

**Pillows:**  
Q.ty 01 Cod.CU58 leather: Princess Col.3527 Cat.3500  
Q.ty 01 Cod.CU68 leather: Princess Col.3527 Cat.3500  
Q.ty 01 Cod.CU57 leather: Princess Col.3527 Cat.3500

**Coffee Table Plane (Cod.T911)**  
Top: wood in Canaletto walnut (Cod.10)  
Metal structure: Antique bronze (Cod.52)

**Coffee Table Fly (Cod.T909)**  
Metal structure: Antique bronze (Cod.52)

**Coffee Table Fly Small (Cod.T910)**  
Metal structure: Antique bronze (Cod.52)



p. 218 / 219

## Bric

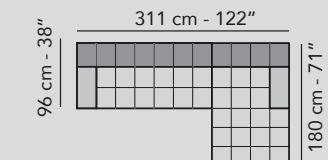

**Bric (Cod.3002+5251+8093)**  
**Bric (Cod.3002+5251)**  
Tessuto: L1317 Col.03 Cat.G - Collezione Hi-Tech  
Piedi: materiale termoplastico nero  
**Bric (Cod.8093)**  
Pelle: Colorado Col.2551 Cat.2500  
Piedi: materiale termoplastico nero

**Cuscini:**  
n°02 Cod.CU57 pelle: Colorado Col.2551 Cat.2500

**Tavolino Metrico (Cod.T905)**  
Ripiano: Vetro stampato (Cod.VS)  
Struttura: metallo Canna di fucile (Cod.50)

**Bric (Cod.3002+5251+8093)**  
**Bric (Cod.3002+5251)**  
Fabric: L1317 Col.03 Cat.G - Hi-Tech Collection  
Legs: black thermoplastic material  
**Bric (Cod.8093)**  
Leather: Colorado Col.2551 Cat.2500  
Legs: black thermoplastic material

**Pillows:**  
Q.ty 02 Cod.CU57 leather: Colorado Col.2551 Cat.2500

**Coffee Table Metrico (Cod.T905)**  
Top: Printed glass (Cod.VS)  
Metal structure: Gunmetal (Cod.50)





**Cadorna (Cod.5232+3061+5253 x 2)**  
**Cadorna (Cod.5232+3061)**  
 Tessuto: VEG Col.48 Cat.G - Collezione Florence  
**Cadorna (Cod.5253 x 2)**  
 Pelle: Nabuk Col.5010 Cat.5000  
 Piedi: metallo Canna di fucile (Cod.50)

**Cuscini:**  
 n°01 Cod.CU68 tessuto: L1575/TOD Col.10 Cat.G - Collezione Florence  
 n°01 Cod.CU57 tessuto: VEG Col.48 Cat.G - Collezione Florence  
 n°01 Cod.CU57 tessuto: L1575/TOD Col.10 Cat.G - Collezione Florence  
 n°02 Cod.CU68 pelle: Nabuk Col.5010 Cat.5000

**Moscova (Cod.1000)**  
 Tessuto: L1597/TRA Col.04 Cat.G - Collezione Florence  
 Struttura: metallo Canna di fucile (Cod.50)

**Tavolino Plane (Cod.T911)**  
 Ripiano: legno Noce canaletto (Cod.10)  
 Struttura: metallo Bronzo anticato (Cod.52)



**Cadorna (Cod.3002+3001)**  
 Tessuto: L1575/TOD Col. 03 Cat.G - Collezione Florence  
**Cadorna (Cod.1202+1841+9503)**  
 Pelle: Colorado Col.2550 Cat.2500  
 Piedi: metallo Ottone satinato (Cod.51)  
 Accessorio Tavolino Terminale (Cod.9503) - Ripiano: marmo Emperador (Cod. EM) - Struttura: metallo Canna di fucile (Cod.50)

**Pouf Square (Cod.8015)**  
 Tessuto: VEG Col. 41 Cat.G - Collezione Florence  
 Piedi: materiale termoplastico nero

**Cuscini:**  
 n°01 Cod.CU57 tessuto: VEG Col.41 Cat.G - Collezione Florence

**Tavolino Fly (Cod.T909) - Tavolino Fly Small (Cod.T910)**  
 Struttura: metallo Bronzo anticato (Cod.52)

**Tavolino Fly (Cod.T909) - Tavolino Fly Small (Cod.T910)**  
 Struttura: metallo Ottone satinato (Cod.51)

p. 200 / 201

## Cadorna

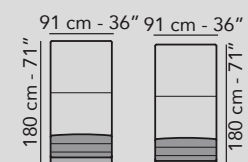
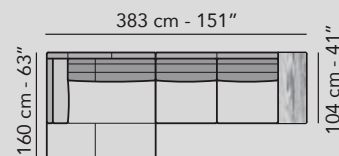

**Cadorna (Cod.5232+3061+5253 x 2)**  
**Cadorna (Cod.5232+3061)**  
 Fabric: VEG Col.48 Cat.G - Florence Collection  
**Cadorna (Cod.5253 x 2)**  
 Leather: Nabuk Col.5010 Cat.5000  
 Metal legs: Gunmetal (Cod.50)

**Pillows:**  
 Q.ty 01 Cod.CU68 fabric: L1575/TOD Col.10 Cat.G - Florence Collection  
 Q.ty 01 Cod.CU57 fabric: VEG Col.48 Cat.G - Florence Collection  
 Q.ty 01 Cod.CU57 fabric: L1575/TOD Col.10 Cat.G - Florence Collection  
 Q.ty 02 Cod.CU68 leather: Nabuk Col.5010 Cat.5000

**Moscova (Cod.1000)**  
 Fabric: L1597/TRA Col.04 Cat.G - Florence Collection  
 Metal structure: Gunmetal (Cod.50)

**Coffee Table Plane (Cod.T911)**  
 Top: wood in Canaletto walnut (Cod.10)  
 Metal structure: Antique bronze (Cod.52)

p. 208 / 209

## Cadorna

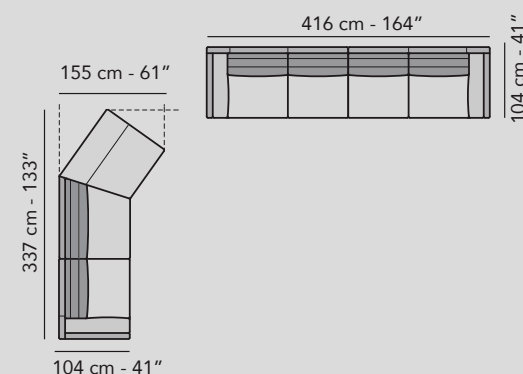

**Cadorna (Cod.3002+3001)**  
 Fabric: L1575/TOD Col.03 Cat.G - Florence Collection  
**Cadorna (Cod.1202+1841+9503)**  
 Leather: Colorado Col.2550 Cat.2500  
 Metal legs: Satin brass (Cod.51)  
 Optional Terminal Table (Cod.9503) - Top: Emperador marble (Cod.EM) - Metal structure: Gunmetal (Cod.50)

**Footstool Square (Cod.8015)**  
 Fabric: VEG Col.41 Cat.G - Florence Collection  
 Legs: black thermoplastic material

**Pillows:**  
 Q.ty 01 Cod.CU57 fabric: VEG Col.41 Cat.G - Florence Collection

**Coffee Table Fly (Cod.T909) - Coffee Table Fly Small (Cod.T910)**  
 Metal structure: Antique Bronze (Cod.52)

**Coffee Table Fly (Cod.T909) - Coffee Table Fly Small (Cod.T910)**  
 Metal structure: Satin brass (Cod.51)



**Cairoli/Cairoli Deep (Cod.D1921+D1203 +1203+8027+3202)**  
 Tessuto: DAM Col.37 Cat.D - Collezione Eclettica  
 Piedi: materiale termoplastico nero

**Cuscini:**  
 n°01 Cod.CU58 tessuto: DAM Col.37 Cat.D - Collezione Eclettica  
 n°01 Cod.CU58 tessuto: VEG Col.12 Cat.G - Collezione Florence  
 n°01 Cod.CU68 pelle: Nabuk Col.5003 Cat.5000  
 n°01 Cod.CU57 pelle: Nabuk Col.5003 Cat.5000

**Rho (Cod.1000 x 2)**  
 Pelle: Nabuk 5003 Cat.5000  
 Struttura: metallo Canna di fucile (Cod.50)

p. 146 / 147

## Cairoli/Cairoli Deep

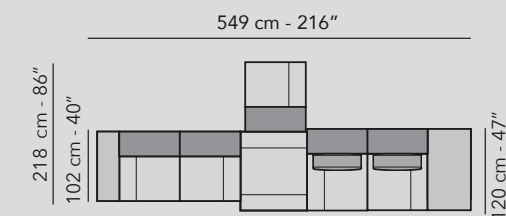

**Cairoli/Cairoli Deep (Cod.D1921+D1203 +1203+8027+3202)**  
 Fabric: DAM Col.37 Cat.D - Eclettica Collection  
 Legs: black thermoplastic material

**Pillows:**  
 Q.ty 01 Cod.CU58 fabric: DAM Col.37 Cat.D - Eclettica Collection  
 Q.ty 01 Cod.CU58 fabric: VEG Col.12 Cat.G - Florence Collection  
 Q.ty 01 Cod.CU68 leather: Nabuk Col.5003 Cat.5000  
 Q.ty 01 Cod.CU57 leather: Nabuk Col.5003 Cat.5000

**Rho (Cod.1000 x 2)**  
 Leather: Nabuk 5003 Cat.5000  
 Metal structure: Gunmetal (Cod.50)



p. 150 / 151

## Cairoli/Cairoli Deep

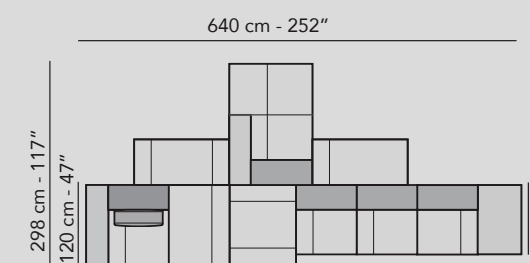

**Cairoli/Cairoli Deep (Cod.1921+1203 x 2+8027+D3232+5201+8098 x 2)**  
**Cairoli (Cod.1921+1203 x 2+5201+8098)**  
 Tessuto: L1569/OLO Col.13 Cat.G - Collezione Florence  
 Piedi: materiale termoplastico nero  
**Cairoli/Cairoli Deep (Cod.8027+8098+D3232)**  
 Pelle: Princess Col.3525 Cat.3500  
 Piedi: materiale termoplastico nero

**Cairoli/Cairoli Deep (Cod.1921+1203 x 2+8027+D3232+5201+8098 x 2)**  
**Cairoli (Cod.1921+1203 x 2+5201+8098)**  
 Fabric: L1569/OLO Col.13 Cat.G - Florence Collection  
 Legs: black thermoplastic material  
**Cairoli/Cairoli Deep (Cod.8027+8098+D3232)**  
 Leather: Princess Col.3525 Cat.3500  
 Legs: black thermoplastic material





p. 156 / 157

## Cairoli High

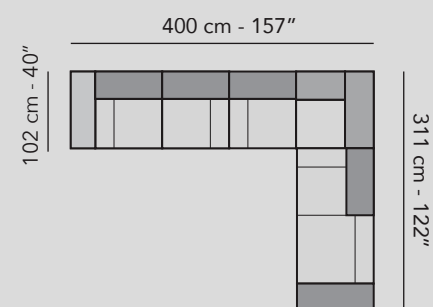

**Cairoli High (Cod.H3202+H1203+H4004+H6032)**

Pelle: Princess Col.3518 Cat.3500

Piedi: materiale termoplastico nero

**Cuscini:**

n°01 Cod.CU57 pelle: Princess Col.3518 Cat.3500

n°01 Cod.CU57 tessuto: L1575/TOD Col.05 Cat.G - Collezione Florence

n°01 Cod.CU68 tessuto: L1575/TOD Col.05 Cat.G - Collezione Florence

**Cairoli High (Cod.H3202+H1203+H4004+H6032)**

Leather: Princess Col.3518 Cat.3500

Legs: black thermoplastic material

**Pillows:**

Q.ty 01 Cod.CU57 leather: Princess Col.3518 Cat.3500

Q.ty 01 Cod.CU57 fabric: L1575/TOD Col.05 Cat.G - Florence Collection

Q.ty 01 Cod.CU68 fabric: L1575/TOD Col.05 Cat.G - Florence Collection



p. 164 / 165

## Cairoli High

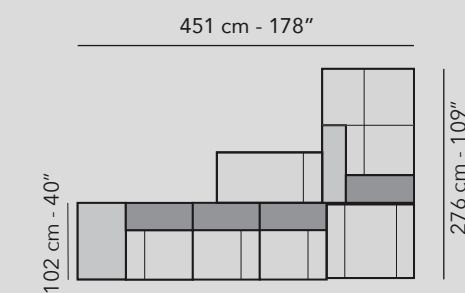

**Cairoli High (Cod.H1922+H1203 x 2+H8027+H5202+H8098)**

**Cairoli High (Cod.H1922+H1203 x 2+H5202)**

Tessuto: L1569/OLO Col.02 Cat.G - Collezione Florence

Piedi: materiale termoplastico nero

**Cairoli (Cod.8027+8098)**

Pelle: Princess Col.3519 Cat.3500

Piedi: materiale termoplastico nero

**Tavolino Metrico (Cod.T905)**

Ripiano: Vetro stampato (Cod.VS)

Struttura: metallo Canna di fucile (Cod.50)

**Tavolino Metrico small (Cod.T906)**

Ripiano: Vetro stampato (Cod.VS)

Struttura: metallo Canna di fucile (Cod.50)

**Cairoli High (Cod.H1922+H1203 x 2+H8027+H5202+H8098)**

**Cairoli High (Cod.H1922+H1203 x 2+H5202)**

Fabric: L1569/OLO Col.02 Cat.G - Florence Collection

Legs: black thermoplastic material

**Cairoli (Cod.8027+8098)**

Leather: Princess Col.3519 Cat.3500

Legs: black thermoplastic material

**Coffee Table Metrico (Cod.T905)**

Top: Printed glass (Cod.VS)

Metal structure: Gunmetal (Cod.50)

**Coffee Table Metrico small (Cod.T906)**

Top: Printed glass (Cod.VS)

Metal structure: Gunmetal (Cod.50)



p. 160 / 161

## Cairoli High

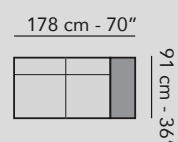

**Cairoli High (Cod.H5203)**

Tessuto: L1575/TOD Col.05 Cat.G - Collezione Florence

Piedi: materiale termoplastico nero

**Tavolino Shiny (Cod.T908)**

Struttura: metallo Bronzo anticato (Cod.52)

**Cairoli High (Cod.H5203)**

Fabric: L1575/TOD Col.05 Cat.G - Florence Collection

Legs: black thermoplastic material

**Coffee Table Shiny (Cod.T908)**

Metal structure: Antique bronze (Cod.52)



p. 240 / 241

## Cordusio

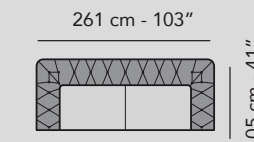

**Cordusio (Cod.3200+8098 x 2)**

**Cordusio (Cod.3200)**

Tessuto: VEG Col. 33 Cat.G - Collezione Florence

Piedi: metallo Canna di fucile (Cod.50)

**Cordusio (Cod.8098 x 2)**

Tessuto: L1592/TRA Col.02 Cat.G - Collezione Florence

Piedi: metallo Canna di fucile (Cod.50)

**Rondò (Cod.1000+9010)**

Tessuto: VEG Col. 33 Cat.G - Collezione Florence

Base: legno rivestito in tessuto VEG Col. 33 Cat.G - Collezione Florence

**Tavolino Deco' (Cod.T903)**

Ripiano superiore: Cuoio marrone (Cod.CM)

Ripiano inferiore: marmo Emperador (Cod.EM)

Struttura: metallo Canna di fucile (Cod.50)

**Cordusio (Cod.3200+8098 x 2)**

**Cordusio (Cod.3200)**

Fabric: VEG Col. 33 Cat.G - Florence Collection

Metal legs: Gunmetal (Cod.50)

**Cordusio (Cod.8098 x 2)**

Fabric: L1592/TRA Col.02 Cat.G - Florence Collection

Metal legs: Gunmetal (Cod.50)

**Rondò (Cod.1000+9010)**

Fabric: VEG Col. 33 Cat.G - Florence Collection

Base: wood covered with fabric VEG Col. 33 Cat.G - Florence Collection

**Coffee Table Deco' (Cod.T903)**

Upper shelf: Brown leather (Cod.CM)

Lower shelf: Emperador marble (Cod.EM)

Metal structure: Gunmetal (Cod.50)





p. 228 / 229

## Duomo

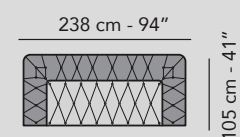

**Duomo (Cod.3000)**  
Pelle: Arizona Col.4080 Cat.4000  
Piedi: metallo Canna di fucile (Cod.50)

**Rho (Cod.1000 x 2)**  
Tessuto: L1575/TOD Col.06 Cat.G - Collezione Florence  
Struttura: metallo Canna di fucile (Cod.50)

**Tavolino Fly (Cod.T909)**  
Struttura: metallo Bronzo anticato (Cod.52)

**Tavolino Fly Small (Cod.T910)**  
Struttura: metallo Bronzo anticato (Cod.52)

**Duomo (Cod.3000)**  
Leather: Arizona Col.4080 Cat.4000  
Metal legs: Gunmetal (Cod.50)

**Rho (Cod.1000 x 2)**  
Fabric: L1575/TOD Col.06 Cat.G - Florence Collection  
Metal structure: Gunmetal (Cod.50)

**Coffee Table Fly (Cod.T909)**  
Metal structure: Antique bronze (Cod.52)

**Coffee Table Fly Small (Cod.T910)**  
Metal structure: Antique bronze (Cod.52)



p. 232 / 233

## Duomo

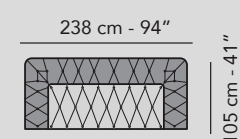

**Duomo (Cod.3000)**  
Pelle: Arizona Col.4088 Cat.4000  
Metal legs: metallo Canna di fucile (Cod.50)

**Lima (Cod.1000 x 2)**  
Tessuto: VEG Col.41 Cat.G - Collezione Florence  
Struttura: metallo Bronzo anticato (Cod.52)

**Tavolino Grancircolo (Cod.T902)**  
Ripiano: marmo Emperador (Cod.EM)  
Struttura: metallo Canna di fucile (Cod.50)

**Tavolino Circolo (Cod.T901)**  
Ripiano: marmo Emperador (Cod.EM)  
Struttura: metallo Canna di fucile (Cod.50)

**Duomo (Cod.3000)**  
Leather: Arizona Col.4088 Cat.4000  
Metal legs: Gunmetal (Cod.50)

**Lima (Cod.1000 x 2)**  
Fabric: VEG Col.41 Cat.G - Collezione Florence  
Metal structure: Antique bronze (Cod.52)

**Coffee Table Grancircolo (Cod.T902)**  
Top: Emperador marble (Cod.EM)  
Metal structure: Gunmetal (Cod.50)

**Coffee Table Circolo (Cod.T901)**  
Top: Emperador marble (Cod.EM)  
Metal structure: Gunmetal (Cod.50)



p. 008 / 009

## Isola

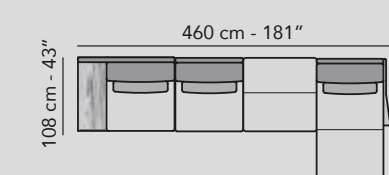

**Isola (Cod.1762+1203+8015+5201)**  
Scocca: pelle Colorado Col.2558 Cat.2500  
Cuscini di seduta/spalliera/cuscinetto lombare: tessuto YUC Col.14 Cat.D - Collezione Eclettica  
Piedi: materiale termoplastico nero  
Elemento contenitore (Cod.02): legno Noce canaletto (Cod.10)

**Tavolino Plane (Cod.T911)**  
Ripiano: legno Noce canaletto (Cod.10)  
Struttura: metallo Bronzo anticato (Cod.52)

**Luis (Cod.1000)**  
Cuscini di seduta e spalliera: pelle Nabuk Col.5003 Cat.5000  
Struttura: metallo Canna di fucile (Cod.50)  
Profilo bracciolo: legno Noce canaletto (Cod.10)

**Isola (Cod.1762+1203+8015+5201)**  
Frame: leather Colorado Col.2558 Cat.2500  
Seat/back and lumbar cushions: fabric YUC Col.14 Cat.D - Eclettica Collection  
Legs: black thermoplastic material  
Storage element (Cod.02): wood in Canaletto walnut (Cod.10)

**Coffee Table Plane (Cod.T911)**  
Top: wood in Canaletto walnut (Cod.10)  
Metal structure: Antique bronze (Cod.52)

**Luis (Cod.1000)**  
Seat and back cushions: leather Nabuk Col.5003 Cat.5000  
Metal structure: Gunmetal (Cod.50)  
Armrest top: wood in Canaletto walnut (Cod.10)



p. 012

## Isola

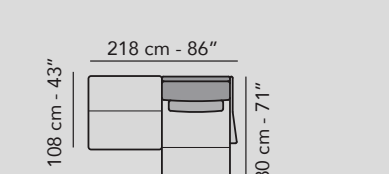

**Isola (Cod.8015+5201)**  
Scocca: pelle Colorado Col.2558 Cat.2500  
Cuscini di seduta/spalliera/cuscinetto lombare: tessuto YUC Col.14 Cat.D - Collezione Eclettica  
Piedi: materiale termoplastico nero

**Cuscini:**  
n°01 Cod.CU58 tessuto: L1575/TOD Col.01 Cat.G - Collezione Florence

**Tavolino Fly (Cod.T909)**  
Struttura: metallo Bronzo anticato (Cod.52)

**Tavolino Fly Small (Cod.T910)**  
Struttura: metallo Bronzo anticato (Cod.52)

**Isola (Cod.8015+5201)**  
Frame: leather Colorado Col.2558 Cat.2500  
Seat/back and lumbar cushions: fabric YUC Col.14 Cat.D - Eclettica Collection  
Legs: black thermoplastic material

**Pillows:**  
Q.ty 01 Cod.CU58 fabric: L1575/TOD Col.01 Cat.G - Florence Collection

**Coffee Table Fly (Cod.T909)**  
Metal structure: Antique bronze (Cod.52)

**Coffee Table Fly Small (Cod.T910)**  
Metal structure: Antique bronze (Cod.52)





p. 014 / 015

## Isola

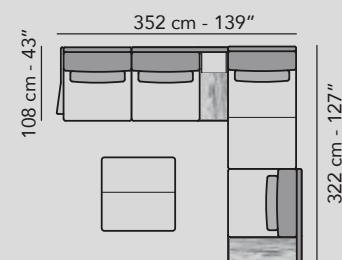

**Isola (Cod.1202+1781+5203+1761+9900+8015)** **Isola (Cod.1202+1781+1761)**  
 Pelle: Nabuk Col.5007 Cat.5000/  
 cuscinetto lombare: tessuto L1571/OVR Col.27 Cat.G - Collezione Florence  
**Isola (Cod.5203)** Tessuto: L1571/OVR Col.27 Cat.G - Collezione Florence /  
 cuscinetto lombare: pelle Nabuk 5007 Cat.5000  
**Isola (Cod.8015)** Tessuto: L1571/OVR Col.27 Cat.G - Collezione Florence  
**Isola (Cod.9900)** Pelle: Nabuk Col.5007 Cat.5000  
 Piedi: materiale termoplastico nero  
 Elementi contenitore (Cod.01/Cod.02): legno Noce canaletto (Cod.10)

**Cuscini:**  
 n°01 Cod.CU57 tessuto: L1571/OVR Col.27 Cat.G - Collezione Florence  
 n°01 Cod.CU71 pelle: Nabuk Col.5007 Cat.5000  
 n°01 Cod.CU57 tessuto: VEG Col.53 Cat.G - Collezione Florence

**Lima (Cod.1000)** Tessuto: VEG Col.53 Cat.G - Collezione Florence  
 Struttura: metallo Bronzo anticato (Cod.52)

**Tavolino Plane (Cod.T911)** - Ripiano: legno Noce canaletto (Cod.10)  
**Tavolino Shiny (Cod.T908)** - Struttura: metallo Bronzo anticato (Cod.52)

**Isola (Cod.1202+1781+5203+1761+9900+8015)** **Isola (Cod.1202+1781+1761)**  
 Leather: Nabuk Col.5007 Cat.5000/  
 Lumbar cushion: fabric L1571/OVR Col.27 Cat.G - Florence Collection  
**Isola (Cod.5203)** Fabric L1571/OVR Col.27 Cat.G - Florence Collection /  
 Lumbar cushion: leather Nabuk 5007 Cat.5000  
**Isola (Cod.8015)** Fabric: L1571/OVR Col.27 Cat.G - Florence Collection  
**Isola (Cod.9900)** Leather: Nabuk Col.5007 Cat.5000  
 Legs: black thermoplastic material  
 Storage elements (Cod.01/Cod.02): wood in Canaletto walnut (Cod.10)

**Pillows:**  
 Q.ty 01 Cod.CU57 fabric: L1571/OVR Col.27 Cat.G - Florence Collection  
 Q.ty 01 Cod.CU71 pelle: Nabuk Col.5007 Cat.5000  
 Q.ty 01 Cod.CU57 fabric: VEG Col.53 Cat.G - Florence Collection

**Lima (Cod.1000)** Fabric: VEG Col.53 Cat.G - Florence Collection  
 Metal structure: Antique bronze (Cod.52)

**Coffee Table Plane (Cod.T911)** Top: wood in Canaletto walnut (Cod.10)  
**Coffee Table Shiny (Cod.T908)** - Metal structure: Antique bronze (Cod.52)

p. 020 / 021

## Isola

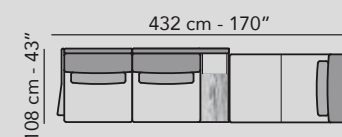

**Isola (Cod.1202+1781+5203)**  
**Isola (Cod.1202+1781)**  
 Pelle: Nabuk Col. 5007 Cat.5000/ cuscinetto lombare: tessuto L1571/OVR  
 Col.27  
 Cat.G - Collezione Florence  
**Isola (Cod.5203)**  
 Tessuto: L1571/OVR Col.27 Cat.G - Collezione Florence  
 Elemento contenitore (Cod.01): legno Noce canaletto (Cod.10)  
 Piedi: materiale termoplastico nero

**Isola (Cod.1202+1781+5203)**  
**Isola (Cod.1202+1781)**  
 Leather: Nabuk Col. 5007 Cat.5000/lumbar cushion: fabric L1571/OVR Col.27  
 Cat.G - Florence Collection  
**Isola (Cod.5203)**  
 Fabric: L1571/OVR Col.27 Cat.G - Florence Collection  
 Storage elements (Cod.01): wood in Canaletto walnut (Cod.10)  
 Legs: black thermoplastic material



p. 022 / 023

## Isola

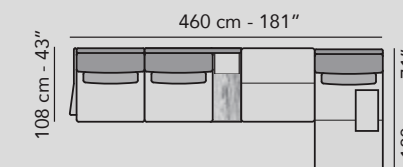

**Isola (Cod.1202+1781+8015+5203+9010+8000)**  
**Isola (Cod.1202+1781)**  
 Pelle: Nabuk Col. 5007 Cat.5000/cuscinetto lombare: tessuto L1571/OVR  
 Col.27 Cat.G - Collezione Florence  
 Elemento contenitore (Cod.01): legno Noce canaletto (Cod.10)  
**Isola (Cod.8015)**  
 Tessuto: L1571/OVR Col.27 Cat.G - Collezione Florence/cuscinetto lombare:  
 Pelle Nabuk Col. 5007 Cat.5000  
**Isola (Cod.9010)**  
 Tessuto: L1571/OVR Col.27 Cat.G - Collezione Florence  
**Isola (Cod.8000)**  
 Tessuto: L1571/OVR Col.27 Cat.G - Collezione Florence  
 Piedi: materiale termoplastico nero

**Tavolino Plane (Cod.T911)**  
 Ripiano: legno Noce canaletto (Cod.10)  
 Struttura: metallo Bronzo anticato (Cod.52)

**Isola (Cod.1202+1781+8015+5203+9010+8000)**  
**Isola (Cod.1202+1781)**  
 Leather: Nabuk Col. 5007 Cat.5000/ lumbar cushion: fabric L1571/OVR Col.27  
 Cat.G - Florence Collection  
 Storage element (Cod.01): wood in Canaletto walnut (Cod.10)  
**Isola (Cod.8015)**  
 Fabric: L1571/OVR Col.27 Cat.G - Florence Collection/lumbar cushion: leather  
 Nabuk Col. 5007 Cat.5000  
 Legs: black thermoplastic material  
**Isola (Cod.9010)**  
 Fabric L1571/OVR Col.27 Cat.G - Florence Collection  
**Isola (Cod.8000)**  
 Fabric: L1571/OVR Col.27 Cat.G - Florence Collection  
 Legs: black thermoplastic material

**Coffee Table Plane (Cod.T911)**  
 Top: wood in Canaletto walnut (Cod.10)  
 Metal structure: Antique bronze (Cod.52)



p. 027

## Isola

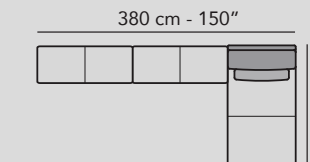

**Isola (Cod.8000 x 2+5203)**  
**Isola (Cod.8000 x 2)**  
 Tessuto: L1571/OVR Col.27 Cat.G - Collezione Florence  
 Piedi: materiale termoplastico nero  
**Isola (Cod.5203)**  
 Tessuto: L1571/OVR Col.27 Cat.G - Collezione Florence/cuscinetto lombare:  
 pelle Nabuk Col. 5007 Cat.5000  
 Piedi: materiale termoplastico nero

**Tavolino Plane (Cod.T911)**  
 Ripiano: legno Noce canaletto (Cod.10)  
 Struttura: metallo Bronzo anticato (Cod.52)

**Isola (Cod.8000 x 2+5203)**  
**Isola (Cod.8000 x 2)**  
 Fabric: L1571/OVR Col.27 Cat.G - Florence Collection  
**Isola (Cod.5203)**  
 Fabric: L1571/OVR Col.27 Cat.G - Florence Collection/lumbar cushion: leather  
 Nabuk Col. 5007 Cat.5000  
 Legs: black thermoplastic material

**Coffee Table Plane (Cod.T911)**  
 Top: wood in Canaletto walnut (Cod.10)  
 Metal structure: Antique bronze (Cod.52)





p. 120 / 121

## Nausicaa

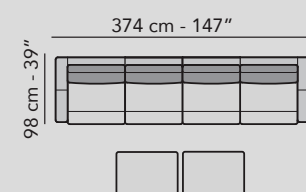

**Nausicaa (Cod.3002+3001+8027 x 2)**  
**Nausicaa (Cod.3002+3001)**  
 Tessuto: VEG Col.76 Cat.G - Collezione Florence  
 Piedi: metallo Canna di fucile (Cod.50)  
**Nausicaa (Cod.8027 x 2)**  
 Pelle: Princess Col.3527 Cat.3500  
 Piedi: metallo Canna di fucile (Cod.50)

**Cuscini:**  
 n°01 Cod.CU68 pelle: Princess Col.3527 Cat.3500  
 n°01 Cod.CU57 pelle: Princess Col.3527 Cat.3500

**Nausicaa (Cod.3002+3001+8027 x 2)**  
**Nausicaa (Cod.3002+3001)**  
 Fabric: VEG Col.76 Cat.G - Florence Collection  
 Metal legs: Gunmetal (Cod.50)  
**Nausicaa (Cod.8027 x 2)**  
 Leather: Princess Col.3527 Cat.3500  
 Metal legs: Gunmetal (Cod.50)

**Pillows:**  
 Q.ty 01 Cod.CU68 leather: Princess Col.3527 Cat.3500  
 Q.ty 01 Cod.CU57 leather: Princess Col.3527 Cat.3500



p. 030 / 031

## Tortona Small

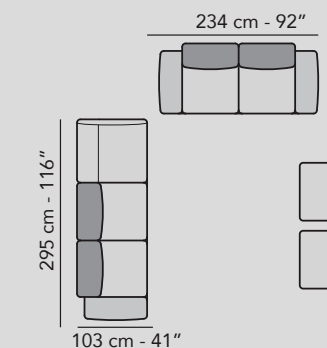

**Tortona Small (Cod.3022+3000+8015 x 2)**  
**Tortona Small (Cod.3022)**  
 Tessuto: VEG Col.10 Cat.G - Collezione Florence  
**Tortona Small (Cod.3000)**  
 Tessuto: L1569/OLO Col.09 Cat.G - Collezione Florence  
**Tortona Small (Cod.8015 x 2)**  
 Tessuto: L1575/TOD Col.14 Cat.G - Collezione Florence  
 Piedi: metallo Canna di fucile (Cod.50) con parte inferiore verniciata in colore oro satinato

**Cuscini:**  
 n°02 Cod.CU68 tessuto: L1575/TOD Col.14 Cat.G - Collezione Florence  
 n°01 Cod.CU58 tessuto: L1569/OLO Col.09 Cat.G - Collezione Florence

**Tavolino Round (Cod.T907)**  
**Tavolino Circolo (Cod.T901)**  
 Ripiano: marmo Emperador (Cod.EM)  
 Struttura: metallo Canna di fucile (Cod.50)

**Tavolino Fly Small (Cod.T910)**  
 Struttura: metallo Bronzo anticato (Cod.52)

**Tortona Small (Cod.3022+3000+8015 x 2)**  
**Tortona Small (Cod.3022)**  
 Fabric: VEG Col.10 Cat.G - Florence Collection  
**Tortona Small (Cod.3000)**  
 Fabric: L1569/OLO Col.09 Cat.G - Florence Collection  
**Tortona Small (Cod.8015 x 2)**  
 Fabric: L1575/TOD Col.14 Cat.G - Florence Collection  
 Metal legs: Gunmetal (Cod.50) with lower part painted in matte gold color

**Pillows:**  
 Q.ty 02 Cod.CU68 fabric: L1575/TOD Col.14 Cat.G - Florence Collection  
 Q.ty 01 Cod.CU58 fabric: L1569/OLO Col.09 Cat.G - Florence Collection

**Coffee Table Round (Cod.T907)**  
**Coffee Table Circolo (Cod.T901)**  
 Top: Emperador marble (Cod.EM)  
 Metal structure: Gunmetal (Cod.50)  
**Coffee Table Fly Small (Cod.T910)**  
 Metal structure: Antique bronze (Cod.52)



p. 126 / 127

## Nausicaa

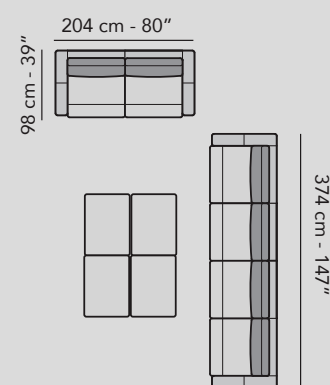

**Nausicaa (Cod.3002+3001+8027 x 4+3000)**  
**Nausicaa (Cod.3002+3001)**  
 Tessuto: VEG Col.76 Cat.G - Collezione Florence  
 Piedi: metallo Canna di fucile (Cod.50)  
**Nausicaa (Cod.8027 x 4)**  
 Tessuto: L1597/TRA Col.09 Cat.G - Collezione Florence  
 Piedi: metallo Canna di fucile (Cod.50)  
**Nausicaa (Cod.3000)**  
 Pelle: Princess Col.3527 Cat.3500  
 Piedi: metallo Canna di fucile (Cod.50)

**Cuscini:**  
 n°01 Cod.CU68 tessuto: VEG Col.53 Cat.G - Collezione Florence  
 n°02 Cod.CU57 pelle: Princess Col.3527 Cat.3500  
 n°02 Cod.CU68 tessuto: L1597/TRA Col.09 Cat.G - Collezione Florence  
 n°01 Cod.CU57 tessuto: VEG Col.53 Cat.G - Collezione Florence  
 n°01 Cod.CU68 tessuto: VEG Col.76 Cat.G - Collezione Florence

**Nausicaa (Cod.3002+3001+8027 x 4+3000)**  
**Nausicaa (Cod.3002+3001)**  
 Fabric: VEG Col.76 Cat.G - Florence Collection  
 Metal legs: Gunmetal (Cod.50)  
**Nausicaa (Cod.8027 x 4)**  
 Fabric: L1597/TRA Col.09 Cat.G - Florence Collection  
 Metal legs: Gunmetal (Cod.50)  
**Nausicaa (Cod.3000)**  
 Leather: Princess Col.3527 Cat.3500  
 Metal legs: Gunmetal (Cod.50)

**Pillows:**  
 Q.ty 01 Cod.CU68 fabric: VEG Col.53 Cat.G - Florence Collection  
 Q.ty 02 Cod.CU57 leather: Princess Col.3527 Cat.3500  
 Q.ty 02 Cod.CU68 fabric: L1597/TRA Col.09 Cat.G - Florence Collection  
 Q.ty 01 Cod.CU57 fabric: VEG Col.53 Cat.G - Florence Collection  
 Q.ty 01 Cod.CU68 fabric: VEG Col.76 Cat.G - Florence Collection



p. 038 / 039

## Tortona Living

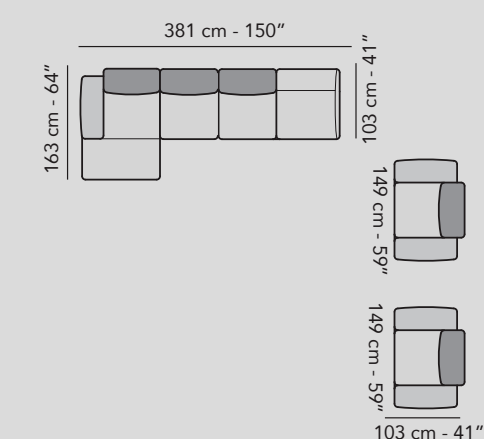

**Tortona Living (Cod.5202+1203+1601+9503)**  
 Pelle: Nabuk Col.5008 Cat.5000  
 Piedi: metallo Canna di fucile (Cod.50) con parte inferiore verniciata in colore oro satinato  
 Accessorio Tavolino Terminale (Cod.9503) - Ripiano: marmo Emperador (Cod.EM) - Struttura: metallo Canna di fucile (Cod.50)

**Cuscini:**  
 n°01 Cod.CU58 tessuto: L1569/OLO Col.13 Cat.G - Collezione Florence  
 n°01 Cod.CU68 tessuto: VEG Col.34 Cat.G - Collezione Florence  
 n°01 Cod.CU40 tessuto: VEG Col.34 Cat.G - Collezione Florence  
 n°01 Cod.CU58 tessuto: VEG Col.34 Cat.G - Collezione Florence

**Tortona Leg (Cod.1200 x 2)**  
 Tessuto: L1542/MAK Col.02 Cat.D - Collezione Eclettica - Piedi: metallo Canna di fucile (Cod.50) con parte inferiore verniciata in colore oro satinato

**Tavolino Round (Cod.T907)**  
 Ripiano: marmo Emperador (Cod.EM)  
 Struttura: metallo Canna di fucile (Cod.50)

**Tortona Living (Cod.5202+1203+1601+9503)**  
 Leather: Nabuk Col.5008 Cat.5000  
 Metal legs: Gunmetal (Cod.50) with lower part painted in matte gold color  
 Optional Terminal Table (Cod.9503)  
 Top: Emperador marble (Cod.EM)  
 Metal structure: Gunmetal (Cod.50)

**Pillows:**  
 Q.ty 01 Cod.CU58 fabric: L1569/OLO Col.13 Cat.G - Florence Collection  
 Q.ty 01 Cod.CU68 fabric: VEG Col.34 Cat.G - Florence Collection  
 Q.ty 01 Cod.CU40 fabric: VEG Col.34 Cat.G - Florence Collection  
 Q.ty 01 Cod.CU58 fabric: VEG Col.34 Cat.G - Florence Collection

**Tortona Leg (Cod.1200 x 2) -**  
 Fabric: L1542/MAK Col.02 Cat.D - Eclettica Collection - Metal legs: Gunmetal (Cod.50) with lower part painted in matte gold color

**Coffee Table Round (Cod.T907)**  
 Top: Emperador marble (Cod.EM)  
 Metal structure: Gunmetal (Cod.50)





**Turro Small (Cod.5202+1702+5201+9503)**

Pelle: Arizona Col.4082 Cat.4000

Piedi: metallo Canna di fucile (Cod.50) con parte inferiore verniciata in colore oro satinato

Accessorio Tavolino Terminale (Cod.9503) - Ripiano: marmo Emperador (Cod.EM) - Struttura: metallo Canna di fucile (Cod.50)

**Cuscini:**

n°01 Cod.CU58 tessuto: L1569/OLO Col.20 Cat.G - Collezione Florence

n°01 Cod.CU58 tessuto: L1575/TOD Col.10 Cat.G - Collezione Florence

**Bonola (Cod.1000)** Scocca: pelle Nabuk Col.5009 Cat.5000 - Cuscini di seduta/spalliera: tessuto L1569/OLO Col.20 Cat.G - Collezione Florence - Poggiatesta: pelle Nabuk Col.5009 Cat.5000 - Base: legno verniciato Wenghè (Cod.05)

**Tavolino Round (Cod.T907)**

**Tavolino Circolo (Cod.T901)**

Ripiano: marmo Emperador (Cod.EM)

Struttura: metallo Canna di fucile (Cod.50)

p. 048 / 049

**Turro Small**

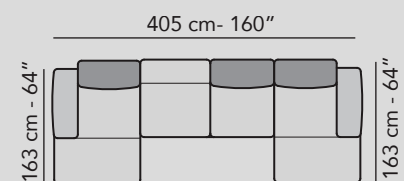

**Turro Small (Cod.5202+1702+5201+9503)**

Leather: Arizona Col.4082 Cat.4000

Metal legs: Gunmetal (Cod.50) with lower part painted in matte gold color

Optional Terminal Table (Cod.9503) - Top: Emperador marble (Cod.EM) - Metal structure: Gunmetal (Cod.50)

**Pillows:**

Q.ty 01 Cod.CU58 fabric: L1569/OLO Col.20 Cat.G - Florence Collection

Q.ty 01 Cod.CU58 fabric: L1575/TOD Col.10 Cat.G - Florence Collection

**Bonola (Cod.1000)** Frame: leather Nabuk Col.5009 Cat.5000 - Seat and back cushions: fabric L1569/OLO Col.20 Cat.G - Florence Collection - Headrest: leather Nabuk Col.5009 Cat.5000 - Base: wood painted in Wenghè (Cod.05)

**Coffee Table Round (Cod.T907)**

**Coffee Table Circolo (Cod.T901)**

Top: Emperador marble (Cod.EM)

Metal structure: Gunmetal (Cod.50)

p. 052 / 053

**Turro Living**

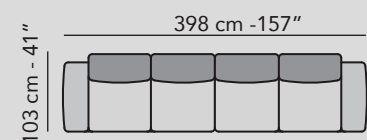

**Turro Living (Cod.3002+3001)**

Fabric: VEG Col.44 Cat.G - Florence Collection

Metal legs: Gunmetal (Cod.50) with lower part painted in matte gold color

**Pillows:**

Q.ty 01 Cod.CU58 fabric: VEG Col.34 Cat.G - Florence Collection

Q.ty 02 Cod.CU57 fabric: L1597/TRA Col.04 Cat.G - Florence Collection

Q.ty 01 Cod.CU68 fabric: VEG Col.34 Cat.G - Florence Collection

**Moscova (Cod.1000 x 2)**

Fabric: L1597/TRA Col.04 Cat.G

Metal structure: Gunmetal (Cod.50)

**Coffee Table Metrico (Cod.T905)**

Top: Printed glass (Cod.VS)

Metal structure: Gunmetal (Cod.50)



**Turro Living (Cod.3002+3001)**

Tessuto: VEG Col.44 Cat.G - Collezione Florence

Piedi: metallo Canna di fucile (Cod.50) con parte inferiore verniciata in colore oro satinato

**Cuscini:**

n°01 Cod.CU58 tessuto: VEG Col.34 Cat.G - Collezione Florence

n°02 Cod.CU57 tessuto: L1597/TRA Col.04 Cat.G - Collezione Florence

n°01 Cod.CU68 tessuto: VEG Col.34 Cat.G - Collezione Florence

**Moscova (Cod.1000 x 2)**

Tessuto: L1597/TRA Col.04 Cat.G

Struttura: metallo Canna di fucile (Cod.50)

**Tavolino Metrico (Cod.T905)**

Ripiano: Vetro stampato (Cod.VS)

Struttura: metallo Canna di fucile (Cod.50)



**Turro Living (Cod.3002+4404+3001)**

Tessuto: VEG Col.44 Cat.G - Collezione Florence

Piedi: metallo Canna di fucile (Cod.50) con parte inferiore verniciata in colore oro satinato

**Cuscini:**

n°01 Cod.CU58 tessuto: VEG Col. 44 Cat.G - Collezione Florence

n°02 Cod.CU57 tessuto: L1540/YAM Col.05 Cat.D - Collezione Eclettica

**Moscova (Cod.1000 x 2)**

Tessuto: L1597/TRA Col.04 Cat.G - Collezione Florence

Struttura: metallo Canna di fucile (Cod.50)

p. 054 / 055

**Turro Living**

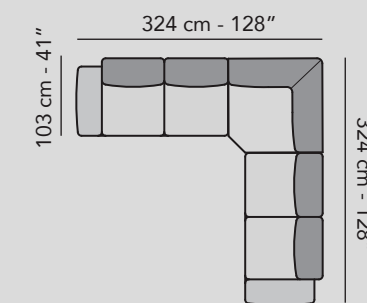

**Turro Living (Cod.3002+4404+3001)**

Fabric: VEG Col.44 Cat.G - Florence Collection

Metal legs: Gunmetal (Cod.50) with lower part painted in matte gold color

**Pillows:**

Q.ty 01 Cod.CU58 fabric: VEG Col. 44 Cat.G - Florence Collection

Q.ty 02 Cod.CU57 fabric: L1540/YAM Col.05 Cat.D - Eclettica Collection

**Moscova (Cod.1000 x 2)**

Fabric: L1597/TRA Col.04 Cat.G - Florence Collection

Metal structure: Gunmetal (Cod.50)



p. 086 / 087

**Zara/Zara Deep**

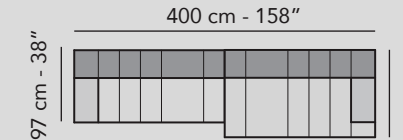

**Zara/Zara Deep (Cod.3002+D3001+ 8098 +D8098)**

Zara/Zara Deep (Cod.3002+D3001)

Tessuto: L1571/OVR Col.92 Cat.G - Collezione Florence

Piedi: legno Laccato nero lucido (Cod.27)

**Zara/Zara Deep (Cod.8098+D8098)**

Tessuto: VEG Col.57 Cat.G - Collezione Florence

Piedi: legno Laccato nero lucido (Cod.27)

**Cuscini:**

n°01 Cod.CU57 tessuto: VEG Col.57 Cat.G - Collezione Florence

n°01 Cod.CU57 tessuto: VEG Col.45 Cat.G - Collezione Florence

n°01 Cod.CU68 tessuto: VEG Col.45 Cat.G - Collezione Florence

**Tavolino Fly (Cod.T909)**

Struttura: metallo Bronzo anticato (Cod.52)

**Tavolino Fly Small (Cod.T910)**

Struttura: metallo Bronzo anticato (Cod.52)

**Zara/Zara Deep (Cod.3002+D3001+ 8098 +D8098)**

Zara/Zara Deep (Cod.3002+D3001)

Fabric: L1571/OVR Col.92 Cat.G - Florence Collection

Wooden legs: Black gloss lacquer (Cod.27)

**Zara/Zara Ddeep (Cod.8098+D8098)**

Fabric: VEG Col.57 Cat.G - Florence Collection

Wooden legs: Black gloss lacquer (Cod.27)

**Pillows:**

Q.ty 01 Cod.CU57 fabric: VEG Col.57 Cat.G - Florence Collection

Q.ty 01 Cod.CU57 fabric: VEG Col.45 Cat.G - Florence Collection

Q.ty 01 Cod.CU68 fabric: VEG Col.45 Cat.G - Florence Collection

**Tavolino Fly (Cod.T909)**

Metal structure: Antique bronze (Cod.52)

**Tavolino Fly Small (Cod.T910)**

Metal structure: Antique bronze (Cod.52)





p. 092 / 093

## Zara/Zara Deep

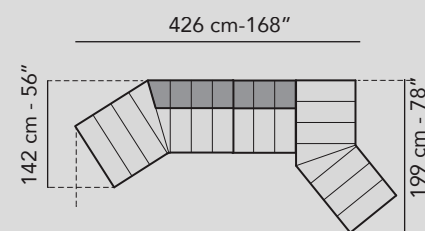

**Zara/Zara Deep (Cod.1842+9503+1203+ D8002)**  
**Zara (Cod.1842+1203)**  
 Pelle: Colorado Col.2560 Cat.2500  
 Inserto: tessuto RIO Col.610 Cat.D - Collezione Covering Hi-tech  
 Piedi: legno Laccato nero lucido (Cod.27)

**Zara Deep (D8002)**  
 Tessuto: VEG Col.83 Cat.G - Collezione Florence  
 Piedi: legno Laccato nero lucido (Cod.27)  
**Accessorio Tavolino Terminale (Cod.9503)**  
 Ripiano: marmo Emperador (Cod.EM)  
 Struttura: metallo Canna di fucile (Cod.50)

**Zara/Zara Deep (Cod.1842+9503+1203+ D8002)**  
**Zara (Cod.1842+1203)**  
 Leather: Colorado Col.2560 Cat.2500  
 Insert: fabric RIO Col.610 Cat.D - Covering Hi-tech Collection  
 Wooden legs: Black gloss lacquer (Cod.27)

**Zara Deep (Cod.D8002)**  
 Fabric: VEG Col.83 Cat.G - Florence Collection  
 Wooden legs: Black gloss lacquer (Cod.27)  
**Optional Terminal Table (Cod.9503)**  
 Top: Emperador marble (Cod.EM)  
 Metal structure: Gunmetal (Cod.50)



p. 102 / 103

## Zara Light

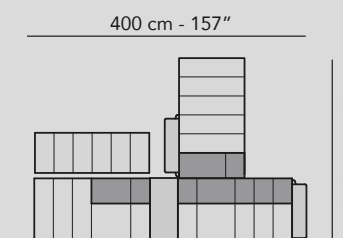

**Zara Light (Cod.L3001+L1702+L6031)**  
 Tessuto: L1569/OLO Col.15 Cat.G - Collezione Florence  
 Bracciolo: pelle Colorado Col.2551 Cat.2500  
**Zara Light (Cod.9504)**  
 Elemento contenitore: legno Noce canaletto (Cod.10)  
**Zara Light (Cod.L8098)**  
 Tessuto: VEG Col.34 Cat.G - Collezione Florence  
 Piedi: legno Laccato nero lucido (Cod.27)

**Cuscini:**  
 n°02 Cod.CU68 tessuto: VEG Col.34 Cat.G - Collezione Florence  
 n°01 Cod.CU58 tessuto: L1597/TRA Col.03 Cat.G - Collezione Florence

**Lima (Cod.1000 x 2)**  
 Tessuto: VEG Col.34 Cat.G - Collezione Florence  
 Struttura: metallo Bronzo anticato (Cod.52)

**Tavolino Astratto (Cod.T900)**  
 Ripiano: Vetro stampato (Cod.VS)  
 Struttura: metallo Canna di fucile (Cod.50)

**Zara Light (Cod.L3001+L1702+L6031)**  
 Fabric: L1569/OLO Col.15 Cat.G - Florence Collection  
 Armrests: leather Colorado Col.2551 Cat.2500  
**Zara Light (Cod.9504)**  
 Storage element: wood in Canaletto walnut (Cod.10)  
**Zara Light (Cod.L8098)**  
 Fabric: VEG Col.34 Cat.G - Florence Collection  
 Wooden legs: Black gloss lacquered (Cod.27)

**Pillows:**  
 Q.ty 02 Cod.CU68 fabric: VEG Col.34 Cat.G - Florence Collection  
 Q.ty 01 Cod.CU58 fabric: L1597/TRA Col.03 Cat.G - Florence Collection

**Lima (Cod.1000 x 2)**  
 Fabric: VEG Col.34 Cat.G - Florence Collection  
 Metal structure: Antique bronze (Cod.52)

**Coffee Table Astratto (Cod.T900)**  
 Top: Printed glass (Cod.VS)  
 Metal structure: Gunmetal (Cod.50)



p. 098 / 099

## Zara Deep

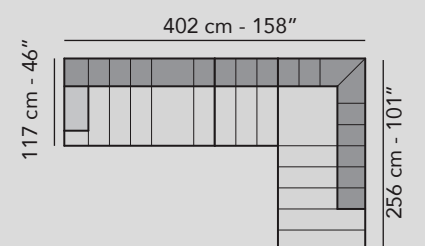

**Zara Deep (Cod.D3002+D1203+ D4231)**  
**Zara Deep (Cod.D3002+D1203)**  
 Pelle: Colorado Col.2551 Cat.2500  
 Inserto: tessuto RIO Col.717 Cat.D - Collezione Covering Hi-tech  
 Piedi: legno Laccato nero lucido (Cod.27)

**Zara Deep (Cod.D4231)**  
 Tessuto: VEG Col.34 Cat.G - Collezione Florence  
 Piedi: legno Laccato nero lucido (Cod.27)

**Cuscini:**  
 n°01 Cod.CU57 tessuto: VEG Col.34 Cat.G - Collezione Florence  
 n°01 Cod.CU57 tessuto: L1569/OLO Col.13 Cat.G - Collezione Florence  
 n°01 Cod.CU68 tessuto: VEG Col.34 Cat.G - Collezione Florence  
 n°01 Cod.CU50 tessuto: VEG Col.34 Cat.G - Collezione Florence

**Tavolino Metrico (Cod.T905)**  
 Ripiano: vetro stampato (Cod.VS)  
 Struttura: metallo Canna di fucile (Cod.50)

**Zara Deep (Cod.D3002+D1203+ D4231)**  
**Zara Deep (Cod.D3002+D1203)**  
 Leather: Colorado Col.2551 Cat.2500  
 Insert: fabric RIO Col.717 Cat.D - Covering Hi-tech Collection  
 Wooden legs: Black gloss lacquer (Cod.27)

**Zara Deep (Cod.D4231)**  
 Fabric: VEG Col.34 Cat.G - Florence Collection  
 Wooden legs: Black gloss lacquer (Cod.27)

**Pillows:**  
 Q.ty 01 Cod.CU57 fabric: VEG Col.34 Cat.G - Florence Collection  
 Q.ty 01 Cod.CU57 fabric: L1569/OLO Col.13 Cat.G - Florence Collection  
 Q.ty 01 Cod.CU68 fabric: VEG Col.34 Cat.G - Florence Collection  
 Q.ty 01 Cod.CU50 fabric: VEG Col.34 Cat.G - Florence Collection

**Coffee Table Metrico (Cod.T905)**  
 Top: Printed glass (Cod.VS)  
 Metal structure: Gunmetal (Cod.50)



p. 106 / 107

## Zara Light

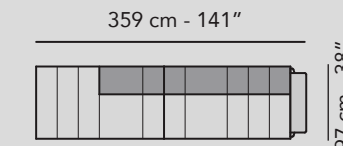

**Zara Light (Cod.L3001+L1702)**  
 Tessuto: L1569/OLO Col.15 Cat.G - Collezione Florence  
 Bracciolo: pelle Colorado Col.2551 Cat.2500  
 Piedi: legno Laccato nero lucido (Cod.27)

**Cuscini:**  
 n°01 Cod.CU68 tessuto: VEG Col.83 Cat.G - Collezione Florence

**Tavolino Plane (Cod.T911)**  
 Ripiano: legno Noce canaletto (Cod.10)  
 Struttura: metallo Bronzo anticato (Cod.52)

**Tavolino Metrico (Cod.T905)**  
 Ripiano: marmo Emperador (Cod.EM)  
 Struttura: metallo Canna di fucile (Cod.50)

**Zara Light (Cod.L3001+L1702)**  
 Fabric: L1569/OLO Col.15 Cat.G - Florence Collection  
 Armrests: leather Colorado Col. 2551 Cat.2500  
 Wooden legs: Black gloss lacquered (Cod.27)

**Pillows:**  
 Q.ty 01 Cod.CU68 fabric: VEG Col.83 Cat. G - Florence Collection

**Coffee Table Plane (Cod.T911)**  
 Wooden Top: Canaletto Walnut (Cod.10)  
 Metal structure: Antique Bronze (Cod.52)

**Coffee Table Metrico (Cod.T905)**  
 Top: Emperador Marble (Cod.EM)  
 Metal structure: Gunmetal (Cod.50)





p. 108

## Zara Light

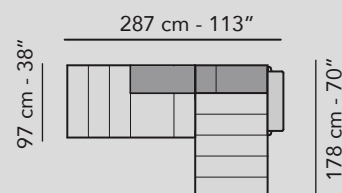

**Zara Light (Cod.L6031+L1702)**  
 Tessuto: L1569/OLO Col.15 Cat.G - Collezione Florence  
 Bracciolo: pelle Colorado Col. 2551 Cat.2500  
 Piedi: legno Laccato nero lucido (Cod.27)

**Cuscini:**  
 n°01 Cod.CU58 tessuto: L1597/TRA Col.03 Cat.G - Collezione Florence

**Tavolino Metrico Small (Cod.T906)**  
 Ripiano: Vetro stampato (Cod.VS)  
 Struttura: metallo Canna di fucile (Cod.50)

**Zara Light (Cod.L6031+L1702)**  
 Fabric: L1569/OLO Col.15 Cat.G - Florence Collection  
 Armrests: leather Colorado Col. 2551 Cat.2500  
 Wooden legs: Black gloss lacquered (Cod.27)

**Pillows:**  
 Q.ty 01 Cod.CU58 fabric: L1597/TRA Col.03 Cat.G - Florence Collection

**Coffee Table Metrico Small (Cod.T906)**  
 Top: Printed glass (Cod.VS)  
 Metal structure: Gunmetal (Cod.50)



p. 112 / 113

## Zara Cuoio

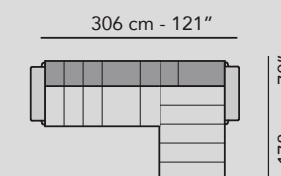

**Zara Cuoio (Cod.C3002+C6031)**  
 Tessuto:L1575/TOD Col.01 Cat.G -Collezione Florence-  
 Piedi: legno Laccato nero lucido (Cod.27)  
 Bracciolo in cuoio:Col.01

**Cuscini:**  
 n°01 CU58 tessuto L1575/TOD Col.01 Cat.G -Collezione Florence-

**Tavolino Metrico (Cod.T907)**  
 Ripiano:marmo Emperador (Cod.EM)  
 Struttura: metallo finitura Canna di fucile (Cod.50)

**Zara Cuoio(Cod.C3002+C6031)**  
 Fabric: L1575/TOD Col.01 Cat.G - Florence Collection  
 Legs: Black gloss lacquered  
 Armrest: Cuoio Col.01

**Pillows:**  
 Q.ty 01 CU58 fabric L1575/TOD Col.01 Cat.G - Florence Collection

**Coffee table Metrico (Cod.T907)**  
 Top: Emperador marble(Cod.EM)  
 Metal structure: Gunmetal(Cod.50)



p. 109

## Zara Light

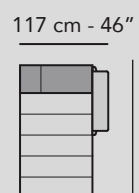

**Zara Light (Cod.L6031)**  
 Tessuto: L1569/OLO Col.15 Cat.G - Collezione Florence  
 Bracciolo: pelle Colorado Col.2551 Cat.2500  
 Piedi: legno Laccato nero lucido (Cod.27)

**Cuscini:**  
 n°01 Cod.CU68 tessuto: VEG Col.34 Cat.G - Collezione Florence

**Tavolino Fly small (T910)**  
 Struttura: metallo Bronzo anticato (Cod.52)

**Zara Light (Cod.L6031)**  
 Fabric: L1569/OLO Col.15 Cat.G - Florence Collection  
 Armrests: leather Colorado Col. 2551 Cat.2500  
 Wooden legs: Black gloss lacquered (Cod.27)

**Pillows:**  
 Q.ty 01 Cod.CU68 fabric: VEG Col.34 Cat.G - Florence Collection

**Fly small (Cod.T910)**  
 Metal structure: Antique bronze (Cod.52)



# Babila

Design Application N° 402017000039849



frontale - front

laterale - depth

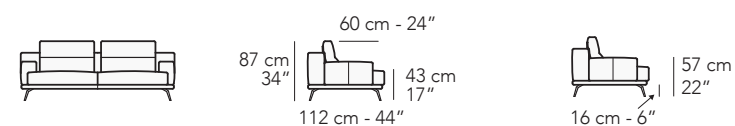

## Caratteristiche standard

- Struttura in legno e multistrato con supporto in metallo, molleggio seduta con cinghie elastiche.
- Cuscini di seduta in poliuretano espanso ecologico a cellula aperta con densità differenziate.
- Cuscini di spalliera in piuma e con supporto schienale in metallo completamente rivestito.
- Rivestimento in pelle o tessuto con cuscini di seduta e spalliera sfoderabili.
- Solo per il mercato ITALIA il rivestimento in tessuto è completamente sfoderabile.
- Piede in metallo Lucido (Cod.30), Satinato (Cod.31), Canna di fucile (Cod.50) e verniciati nei colori RAL opaco: RAL 7006 - RAL 7024 - RAL 7044 - RAL 8019 - RAL 9016.
- Elementi Cod.1431 - 1432 - 1681 - 1682 - 1811 - 1812 - 2251 - 2252 - 2361 - 2362 - 3041 - 3042 - 3061 - 3062 - 3211 - 3212 - 8090 con ripiano in legno Noce canaletto (Cod.10).
- Elementi Cod.1421- 1422- 1671- 1672- 1801- 1802- 2341- 2342- 2371- 2372 - 3031- 3032- 3051- 3052- 3221- 3222- 8091 con ripiano in marmo Emperador (Cod.EM) oppure marmo bianco Carrara (Cod.CA).
- Cucitura Cod.03 per rivestimento in pelle e tessuto.
- Inserimento letto non possibile.
- Lato componibile rifinito.

## Caratteristiche optional su richiesta senza maggiorazione

- Cuscini di seduta con doppia densità poliuretano espanso ecologico a cellula aperta e memory foam rivestito da un materassino in piuma.
- Disponibile con cucitura a contrasto, per la scelta del colore fare riferimento ai codici del campionario pelli.

## Caratteristiche optional su richiesta con maggiorazione

- Per il multi rivestimento il prezzo va incrementato del 7%. Per maggiori dettagli fare riferimento al paragrafo "NOTE" posto nelle prime pagine del listino.

## Note

- Non è possibile applicare altre cuciture.
- Gli elementi 4004 - 4404 - 8090 - 8091 - 8093 possono essere utilizzati indifferente con i gruppi A - B - C.
- I disegni grafici che riportano l'asterisco (\*) sono sempre con lato rifinito e anche agganciabili agli elementi componibili.

## Standard features

- Frame: wooden structure with metal support, seat suspensions in reinforced elastic webbing.
- Padding in eco-friendly open cell polyurethane foam, with different densities.
- Back cushions in feather with back cushion metal support completely covered.
- Covering in leather or fabric. Seat and back cushions coverings removable.
- Legs in Shiny metal (Cod.30), Satin(Cod.31), Gunmetal (Cod.50) and painted in finished RAL colors: RAL 7006 - RAL 7024 - RAL7044 - RAL 8019 - RAL 9016.
- Versions Cod.1431 - 1432 - 1681 - 1682 - 1811 - 1812 - 2251 - 2252 - 2361 - 2362 - 3041 - 3042 - 3061 - 3062 - 3211 - 3212 - 8090 with wooden top in Canaletto walnut (Cod.10).
- Versions Cod.1421- 1422- 1671- 1672- 1801- 1802- 2341- 2342- 2371- 2372 - 3031- 3032- 3051- 3052- 3221- 3222- 8091 with top in marble Emperador (Cod.EM) or Carrara white marble (Cod.CA).
- Stitching type Cod.03 for leather and fabric coverings.
- No bed version available.
- Finished sectional sides.

## Optional features without any upcharge

- Seat cushions in eco-friendly open cell polyurethane foam, with double densities, and memory foam, covered with a feather layer.
- Contrast stitching available. Please refer to our leather collection for a thread color indication.

## Optional features with upcharge

- 7% upcharge for combined coverings. Please refer to the notes at the beginning of pricelist.

## Notes

- Different stitchings not available.
- Versions Cod.4004 - 4404 - 8090 - 8091 - 8093 can be used with groups A - B - C.
- Versions with asterisk (\*) have always the terminal side finished with the possibility to be connected to modular elements.



Piede in metallo // Metal Legs

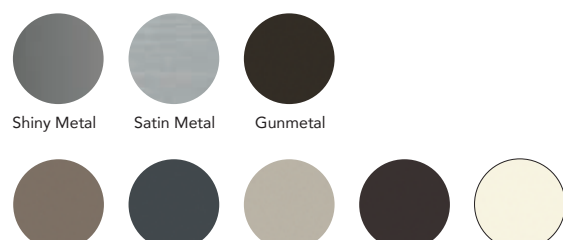

Shiny Metal Satin Metal Gunmetal Ral 7006 Ral 7024 Ral 7044 Ral 8019 Ral 9016

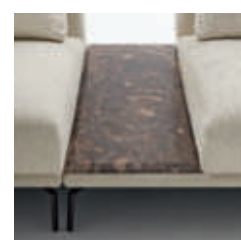

Elementi // Versions

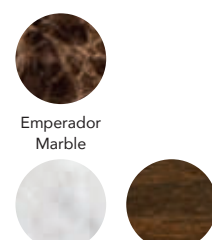

Emperador Marble White Carrara Marble Canaletto Walnut

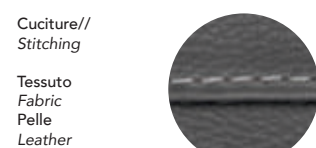

Cuciture // Stitching

Tessuto // Fabric Pelle // Leather

Cod.03

## Versioni \ Versions

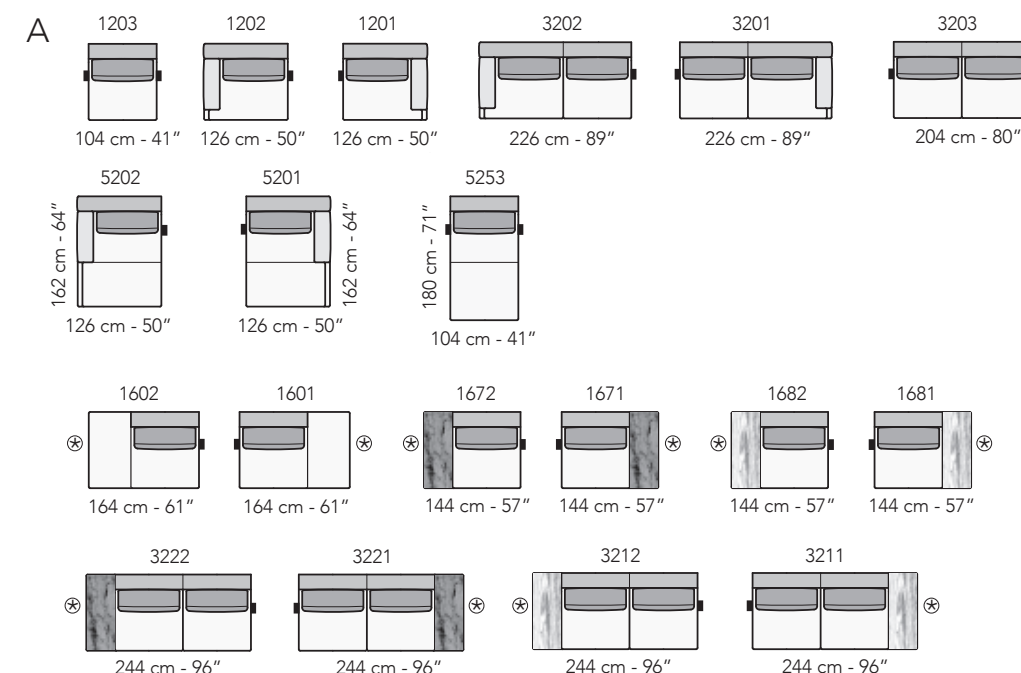
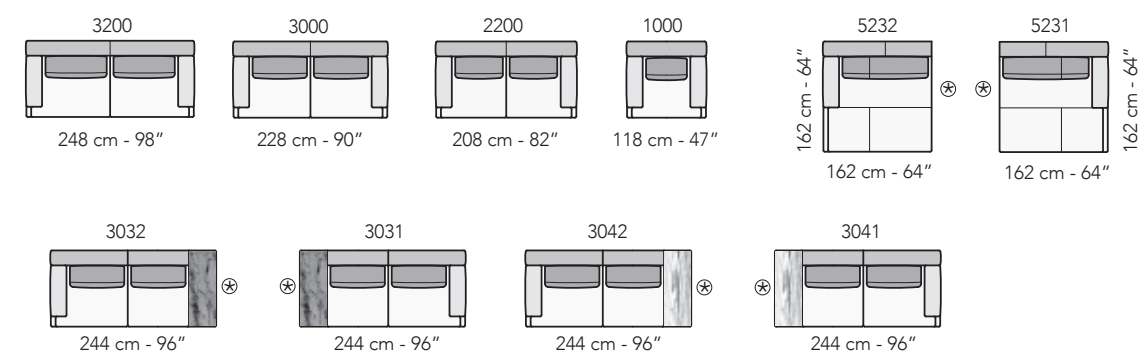

tutti gli elementi del gruppo A hanno lo stesso modulo di seduta - all items in group A have the same seat width

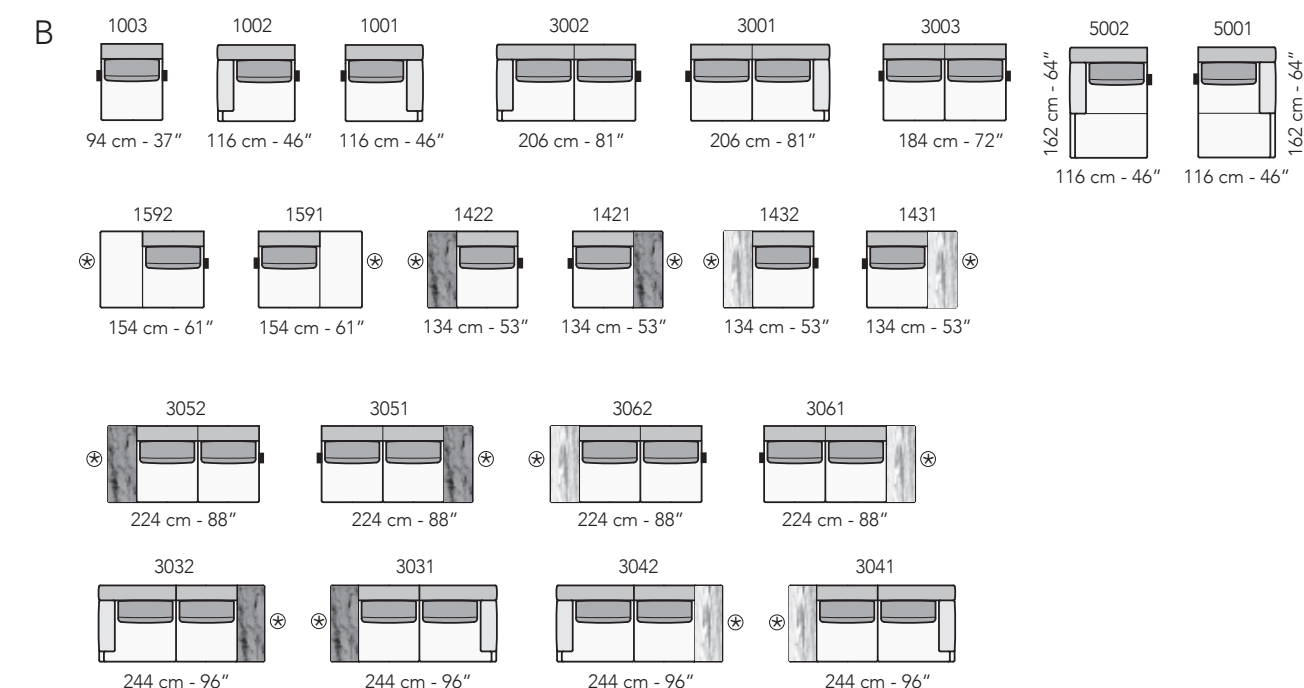

tutti gli elementi del gruppo B hanno lo stesso modulo di seduta - all items in group B have the same seat width



C

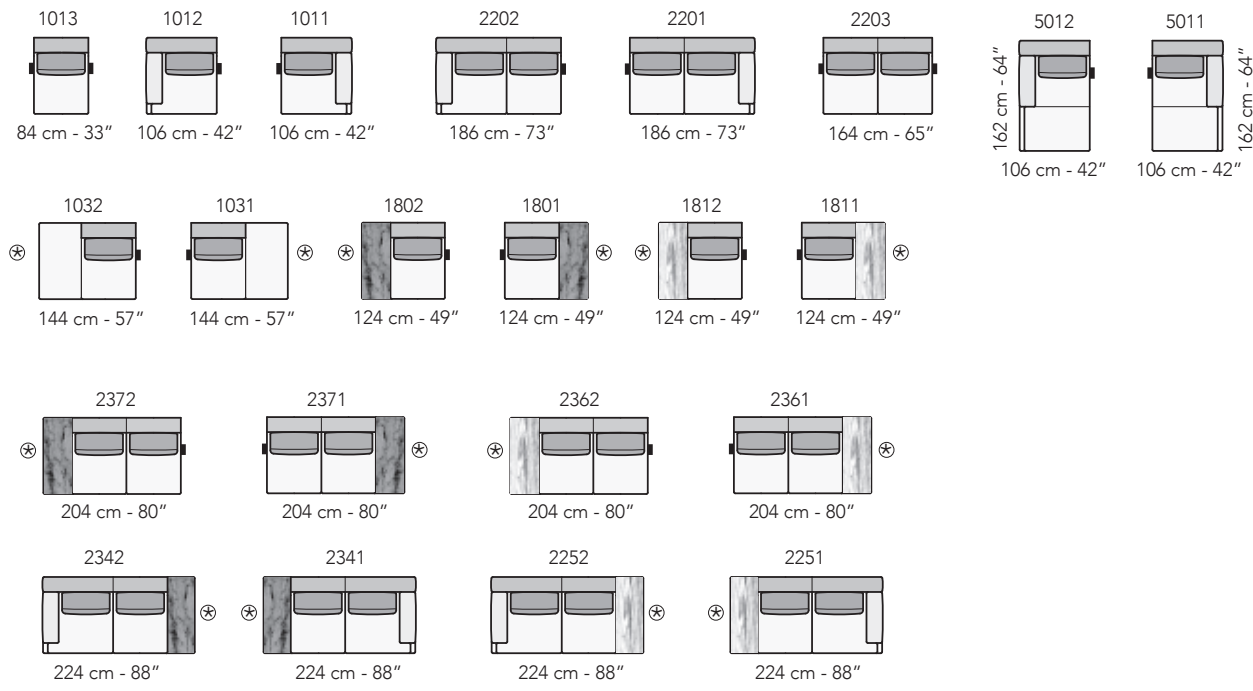

tutti gli elementi del gruppo C hanno lo stesso modulo di seduta - all items in group C have the same seat width

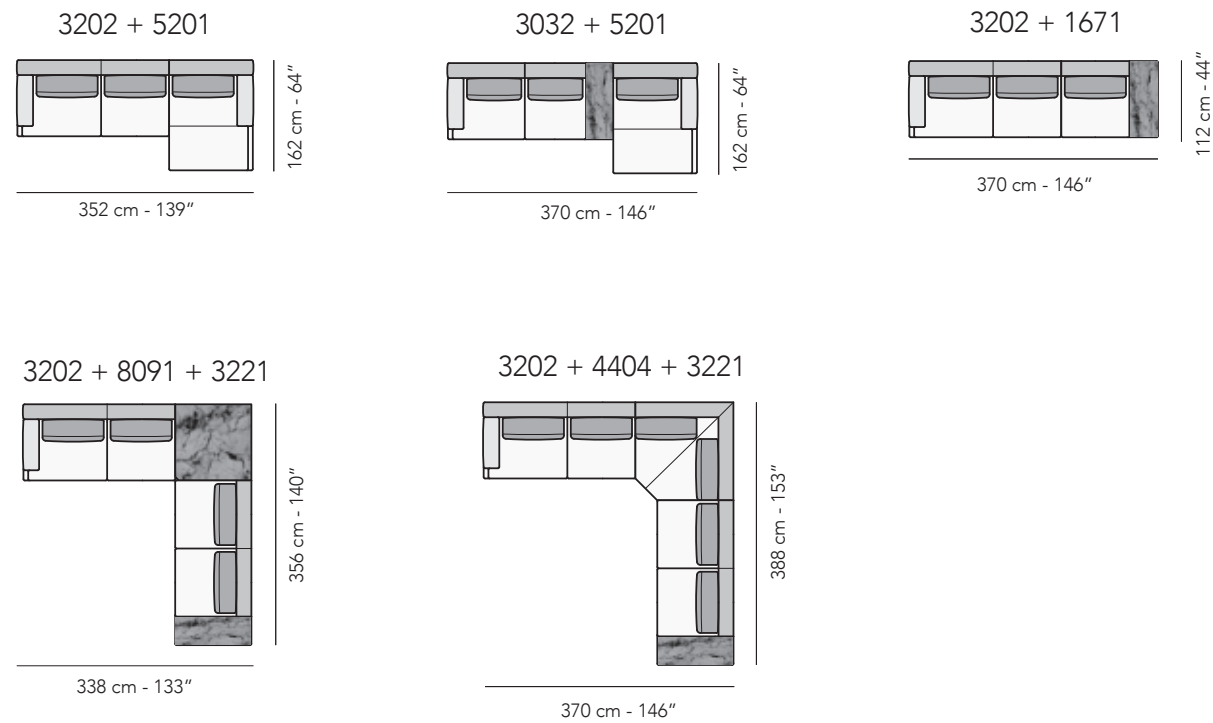
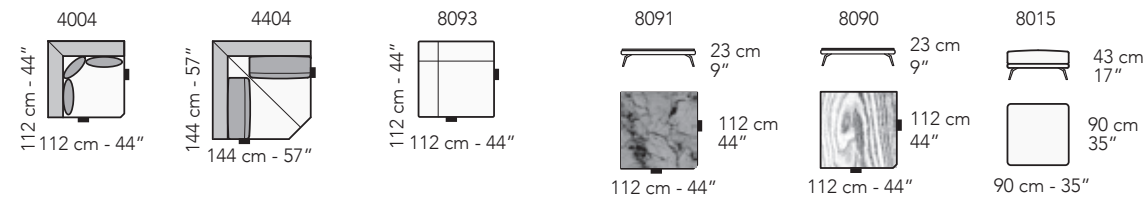

Composizioni consigliate - Recommended compositions

Legenda - Legend

- Spalliera / Back Cushions
- Poggiareni / Kidneyrest
- Bracciolo / Armrest
- Marmo / Marble
- Legno / Wood
- Aggancio Componibile / Connector
- Sistema Sound
- \* Lato terminale sempre rifinito e agganciabile agli elementi componibili / Terminal side is always finished and it can also be connected to modular elements



# Bora

Design Application N° 402017000039849



frontale - front

laterale - depth

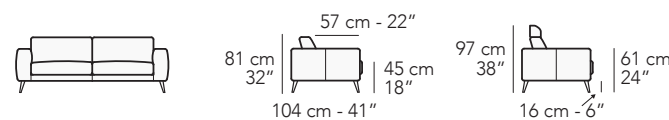

## Caratteristiche standard

- Struttura in legno e multistrato, molleggio seduta con cinghie elastiche.
- Imbottitura in poliuretano espanso ecologico a cellula aperta con densità differenziate, rivestito da falda di Tecnoform.
- Rivestimento in pelle o tessuto con cuscini di seduta e spalliera sfoderabili.
- Solo per il mercato ITALIA il rivestimento in tessuto è completamente sfoderabile.
- Piede in metallo Lucido (Cod.30), Satinato (Cod.31), Canna di fucile (Cod.50).
- Elementi Cod.1431 - 1432 - 1491 - 1492 - 1681 - 1682 - 2041 - 2042 - 2251 - 2252 - 3041 - 3042 - 8090 con ripiano in legno Noce canaletto (Cod.10).
- Elementi Cod.1421 - 1422 - 1501 - 1502 - 1671 - 1672 - 2031 - 2032 - 2341 - 2342 - 3031 - 3032 - 8091 con ripiano in marmo Emperador (Cod.EM) oppure con marmo bianco Carrara (Cod.CA).
- Cucitura Cod.06 per rivestimento in pelle.
- Inserimento letto non possibile.
- Lato componibile rifinito.

## Caratteristiche optional su richiesta senza maggiorazione

- Disponibile con cucitura a contrasto, per la scelta del colore fare riferimento ai codici del campionario pelli.

## Caratteristiche optional su richiesta con maggiorazione

- Poggiatesta (Cod.9900) con imbottitura in poliuretano espanso ecologico a cellula aperta e rivestimento sfoderabile.
- Per il multi rivestimento il prezzo va incrementato del 3%. Per maggiori dettagli fare riferimento al paragrafo "NOTE" posto nelle prime pagine del listino.

## Note

- Non è possibile applicare altre cuciture.
- Gli elementi Cod.4015 - 4404 - 8090 - 8091 possono essere utilizzati indifferente con i gruppi A - B - C.
- I disegni grafici che riportano l'asterisco (\*) sono sempre con lato rifinito e anche agganciabili agli elementi componibili.

## Standard features

- *Frame: wooden structure, seat suspensions in reinforced elastic webbing.*
- *Padding in eco-friendly open cell polyurethane foam, with different densities, covered with a Tecnoform layer.*
- *Covering in leather or fabric. Seat and back cushions coverings removable.*
- *Legs in Shiny metal (Cod.30), Satin (Cod.31), Gunmetal (Cod.50).*
- *Versions Cod.1431 - 1432 - 1491 - 1492 - 1681 - 1682 - 2041 - 2042 - 2251 - 2252 - 3041 - 3042 - 8090 with wooden top in Canaletto walnut (Cod.10).*
- *Versions Cod.1421- 1422- 1501 - 1502 - 1671- 1672- 2031- 2032 - 2341- 2342 - 3031- 3032- 8091 with top in marble Emperador (Cod.EM) or Carrara white marble (Cod.CA).*
- *Stitching type Cod.06 for leather covering.*
- *No bed version available.*
- *Finished sectional sides.*

## Optional features without any upcharge

- *Contrast stitching available. Please refer to our leather collection for a thread color indication.*

## Optional features with upcharge

- *Headrest (Cod.9900) with padding in eco-friendly open cell polyurethane foam. Removable covering.*
- *3% upcharge for combined coverings. Please refer to the notes at the beginning of pricelist.*

## Notes

- *Different stitchings not available.*
- *Versions Cod.4015 - 4404 - 8090 - 8091 can be used with groups A - B - C.*
- *Versions with asterisk (\*) have always the finished terminal side with the possibility to be connected to modular elements.*



Piede in metallo // Metal Legs



Shiny Metal Satin Metal Gunmetal

Cuciture// Stitching

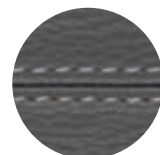

Tessuto Fabric Pelle Leather

Cod.06

## Versioni \ Versions

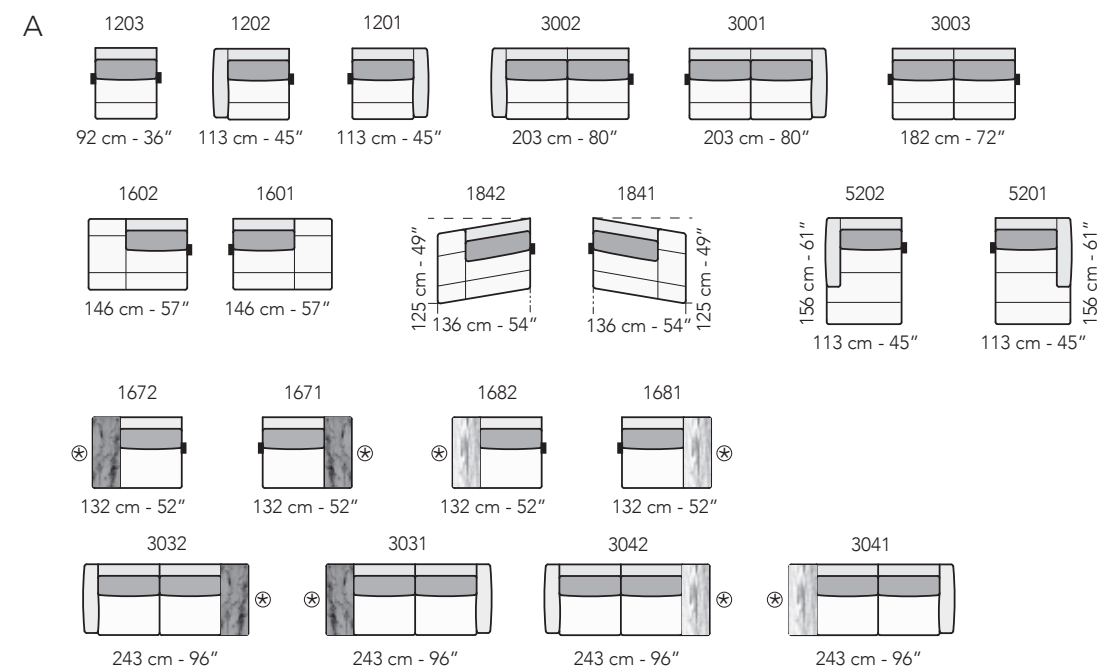
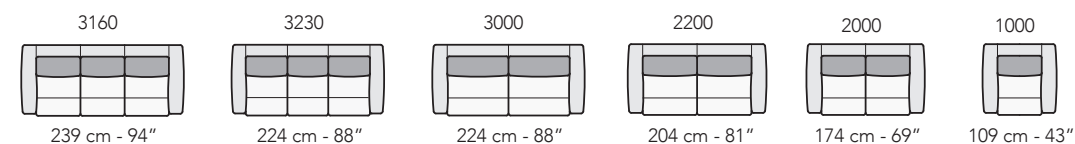

tutti gli elementi del gruppo A hanno lo stesso modulo di seduta - all items in group A have the same seat width

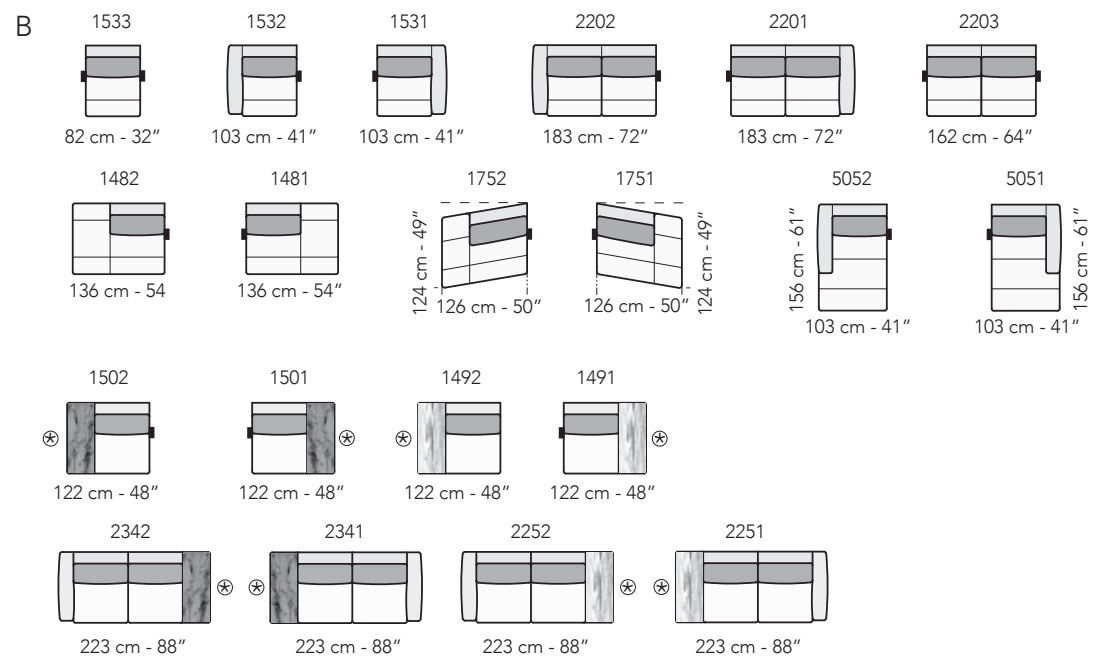

tutti gli elementi del gruppo B hanno lo stesso modulo di seduta - all items in group B have the same seat width



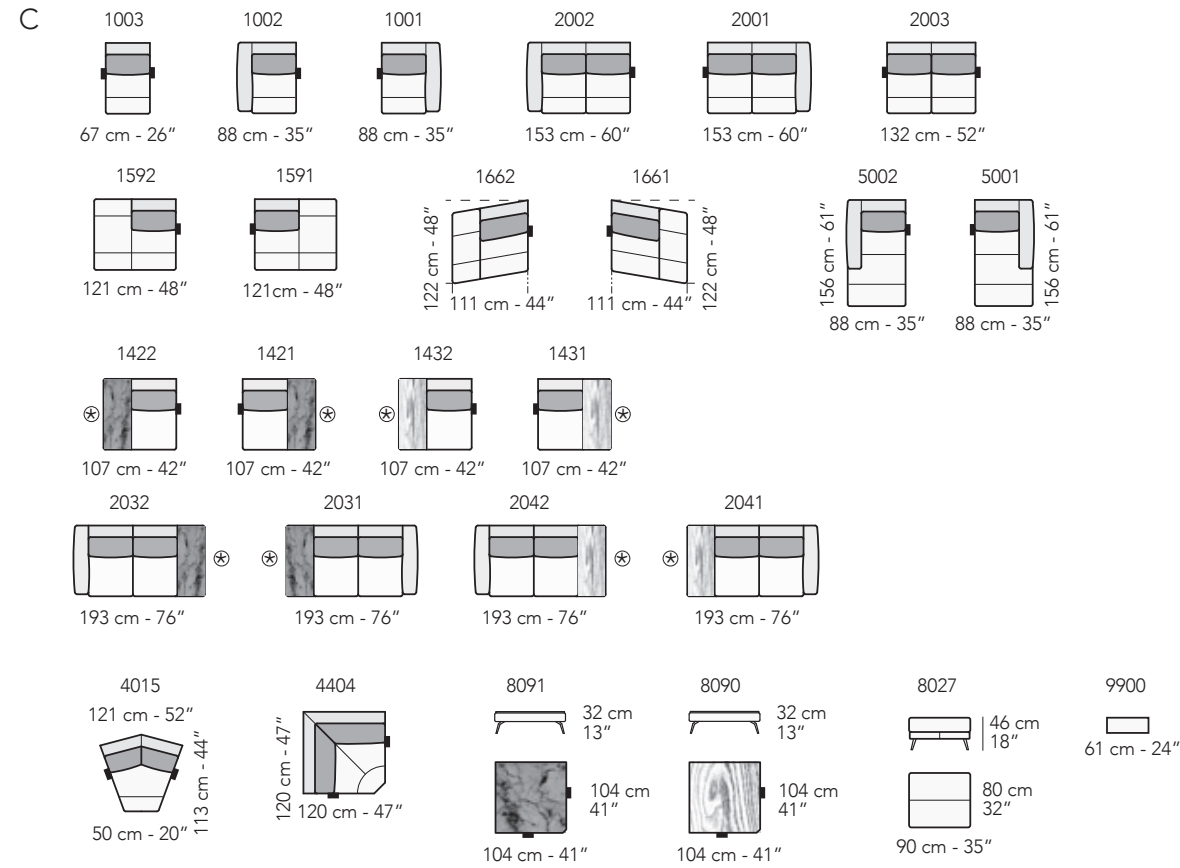

schede tecniche

technical sheet

tutti gli elementi del gruppo C hanno lo stesso modulo di seduta - all items in group C have the same seat width

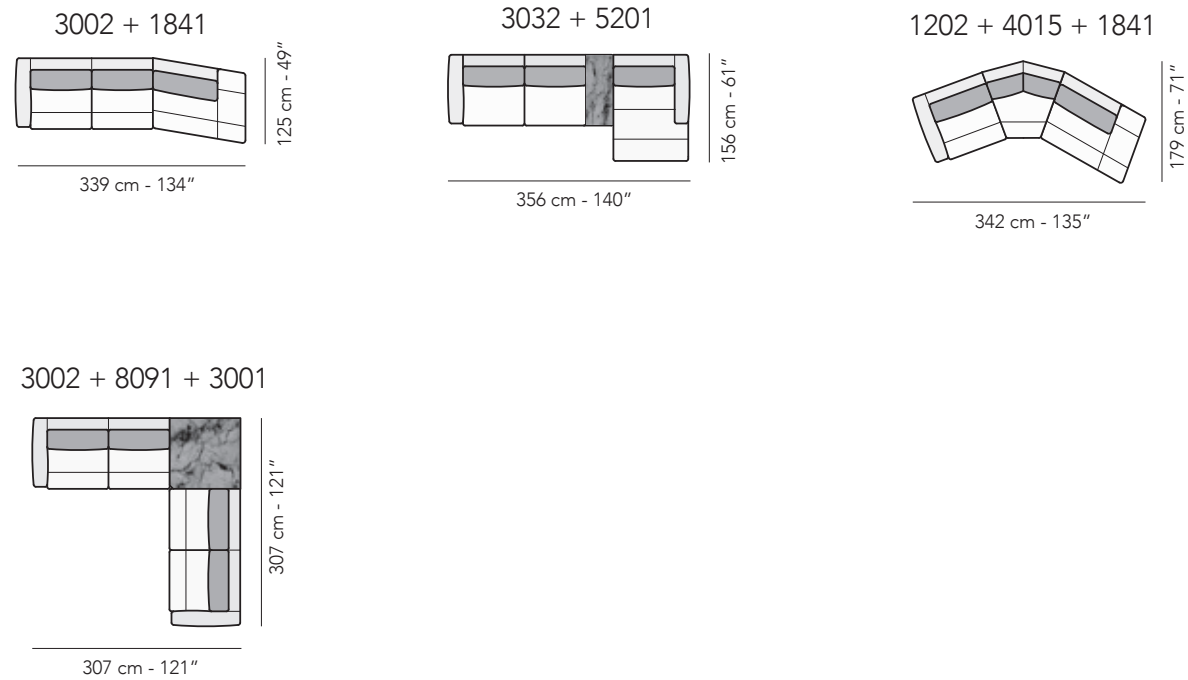

Composizioni consigliate - Recommended compositions

Legenda - Legend

- Spalliera / Back Cushions
- Poggiareni / Kidneyrest
- Bracciolo / Armrest
- Marmo / Marble
- Legno / Wood
- Aggancio Componibile / Connector
- Seduta / Seat Cushions
- Ⓢ Sistema Sound
- \* Lato terminale sempre rifinito e agganciabile agli elementi componibili / Terminal side is always finished and it can also be connected to modular elements



# Bovisa

Design Application N° 402017000039849



frontale - front

laterale - depth

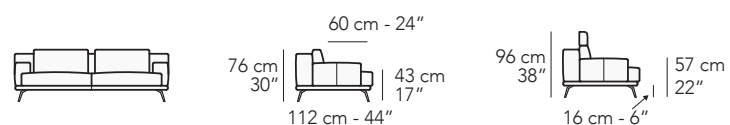

schede tecniche

## Caratteristiche standard

- Struttura in legno e multistrato con supporto in metallo, molleggio seduta con cinghie elastiche.
- Cuscini di seduta in poliuretano espanso ecologico a cellula aperta con densità differenziate.
- Cuscini di spalliera in piuma.
- Rivestimento in pelle o tessuto con cuscini di seduta e spalliera sfoderabili.
- Solo per il mercato ITALIA il rivestimento in tessuto è completamente sfoderabile.
- Piede in metallo Lucido (Cod.30), Satinato (Cod.31), Canna di fucile (Cod.50) e verniciati nei colori RAL opaco: RAL 7006 - RAL 7024 - RAL 7044 - RAL 8019 - RAL 9016.
- Elementi Cod.1431- 1432- 1681- 1682- 1811- 1812- 2251- 2252- 2361- 2362 - 3041- 3042- 3061- 3062- 3211- 3212- 8090 con ripiano in legno Noce canaletto (Cod.10).
- Elementi Cod.1421- 1422- 1671- 1672- 1801- 1802- 2341- 2342- 2371- 2372 - 3031- 3032- 3051- 3052- 3221- 3222- 8091 con ripiano in marmo Emperador (Cod.EM) oppure marmo bianco Carrara (Cod.CA).
- Cucitura Cod.03 per rivestimento in pelle e tessuto.
- Inserimento letto non possibile.
- Lato componibile rifinito.

## Caratteristiche optional su richiesta senza maggiorazione

- Cuscini di seduta con doppia densità poliuretano espanso ecologico a cellula aperta memory foam rivestito da un materassino in piuma.
- Disponibile con cucitura a contrasto, per la scelta del colore fare riferimento ai codici del campionario pelli.

## Caratteristiche optional su richiesta con maggiorazione

- Poggiatesta (Cod.9900) con imbottitura in piuma e supporto in metallo rivestito.
- Per il multi rivestimento il prezzo va incrementato del 7%. Per maggiori dettagli fare riferimento al paragrafo "NOTE" posto nelle prime pagine del listino.

## Note

- Non è possibile applicare altre cuciture.
- Gli elementi Cod.4004 - 4404 - 8090 - 8091 - 8093 possono essere utilizzati indifferentemente con i gruppi A - B - C.
- I disegni grafici che riportano l'asterisco (\*) sono sempre con lato rifinito e anche agganciabili agli elementi componibili.

## Standard features

- *Frame: wooden structure with metal support, seat suspensions in reinforced elastic webbing.*
- *Seat cushions in eco-friendly open cell polyurethane foam, with different densities.*
- *Back cushions in feather.*
- *Covering in leather or fabric. Seat and back cushions coverings removable.*
- *Legs in Shiny metal (Cod.30), Satin (Cod.31), Gunmetal (Cod.50) and painted in finished RAL colors: RAL 7006 - RAL 7024 - RAL7044 - RAL 8019 - RAL 9016.*
- *Versions Cod.1431 - 1432 - 1681 - 1682 - 1811 - 1812 - 2251 - 2252 - 2361 - 2362 - 3041 - 3042 - 3061 - 3062 - 3211 - 3212 - 8090 with wooden top in Canaletto walnut (Cod.10).*
- *Versions Cod.1421- 1422- 1671- 1672- 1801- 1802- 2341- 2342- 2371- 2372 - 3031- 3032- 3051- 3052- 3221- 3222- 8091 with top in marble Emperador (Cod.EM) or Carrara white marble (Cod.CA).*
- *Stitching type Cod.03 for leather and fabric coverings.*
- *No bed version available.*
- *Finished sectional sides.*

## Optional features without any upcharge

- *Seat cushion in eco-friendly open cell polyurethane foam, with double densities, and memory foam, covered with a feather layer.*
- *Contrast stitching available. Please refer to our leather collection for a thread color indication.*

## Optional features with upcharge

- *Headrest (Cod.9900) with feather padding and covered metal structure.*
- *7% upcharge for combined coverings. Please refer to the notes at the beginning of pricelist.*

## Notes

- *Different stitchings not available.*
- *Versions Cod.4004 - 4404 - 8090 - 8091 - 8093 can be used with groups A - B - C.*
- *Versions with asterisk (\*) have always the finished terminal side with the possibility to be connected to modular elements.*

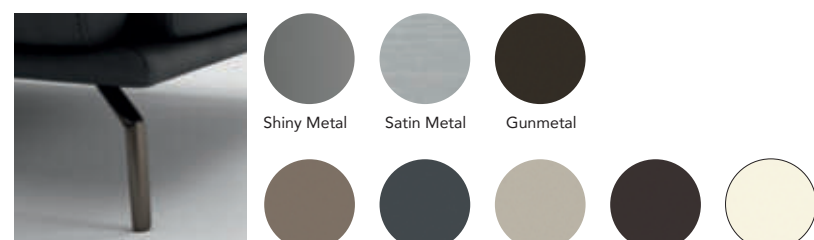

Piede in metallo // Metal Legs

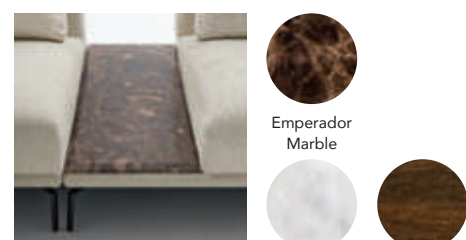

Elementi // Versions

Emperador Marble

White Carrara Marble

Canaletto Walnut

Cuciture// Stitching

Tessuto Fabric  
Pelle Leather

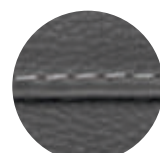

Cod.03

## Versioni \ Versions

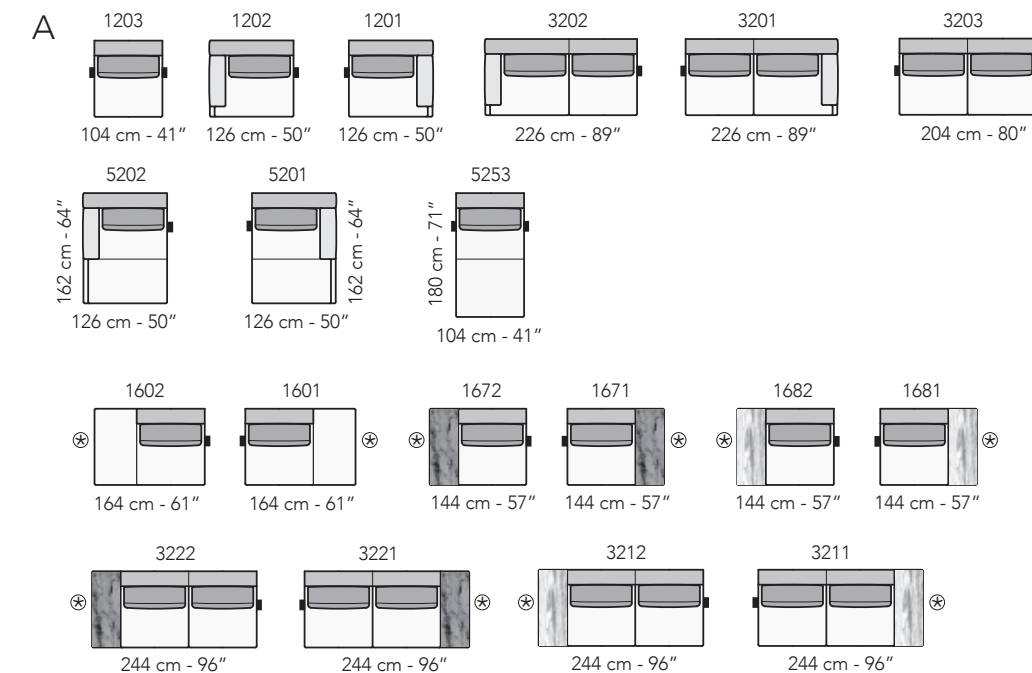
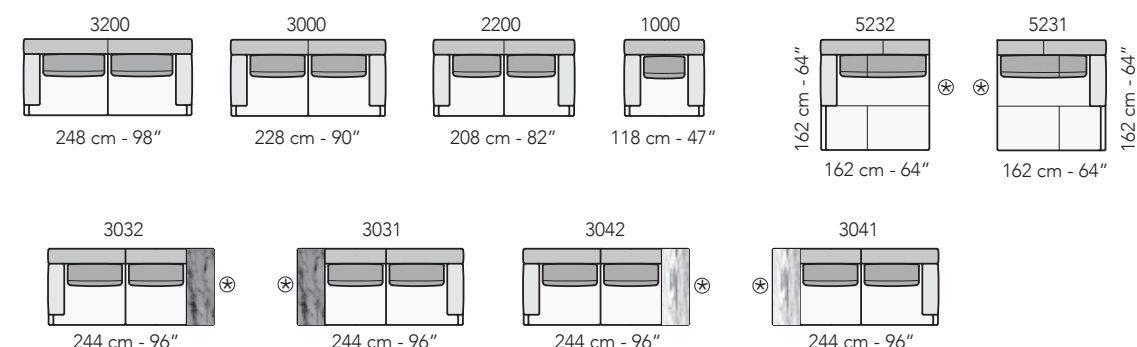

tutti gli elementi del gruppo A hanno lo stesso modulo di seduta - all items in group A have the same seat width

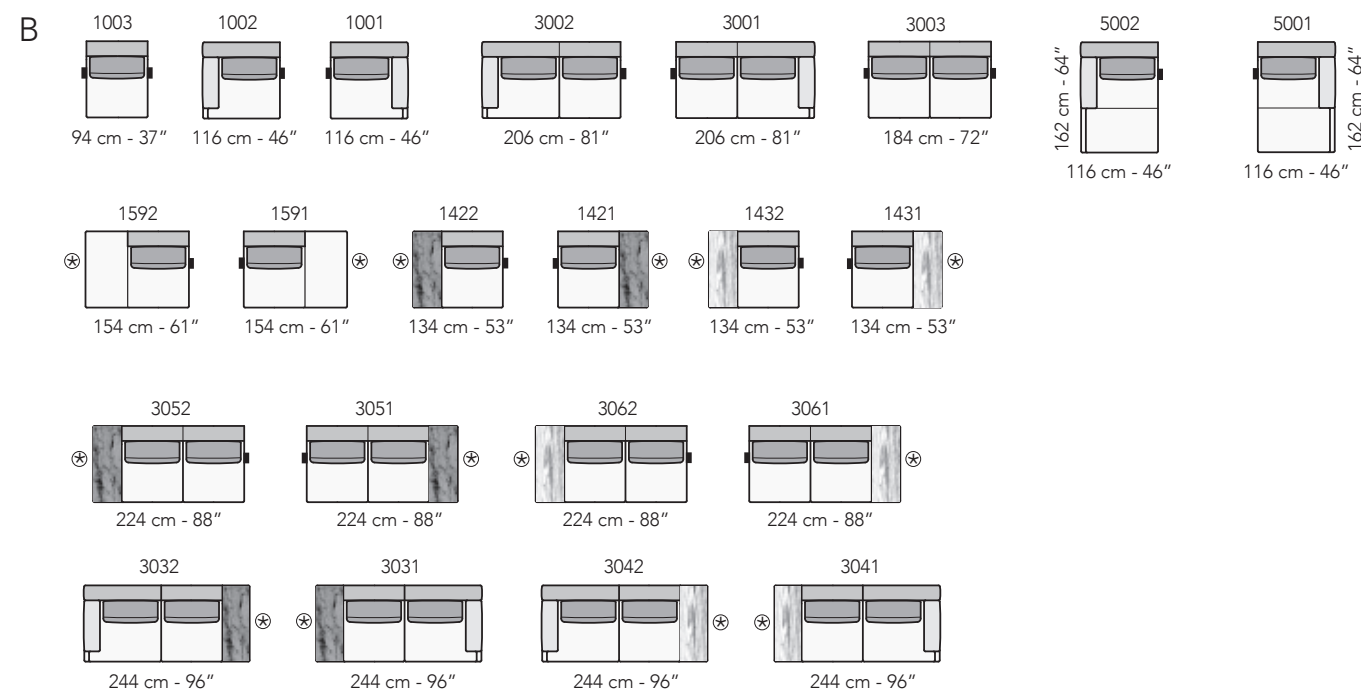

tutti gli elementi del gruppo B hanno lo stesso modulo di seduta - all items in group B have the same seat width

technical sheet



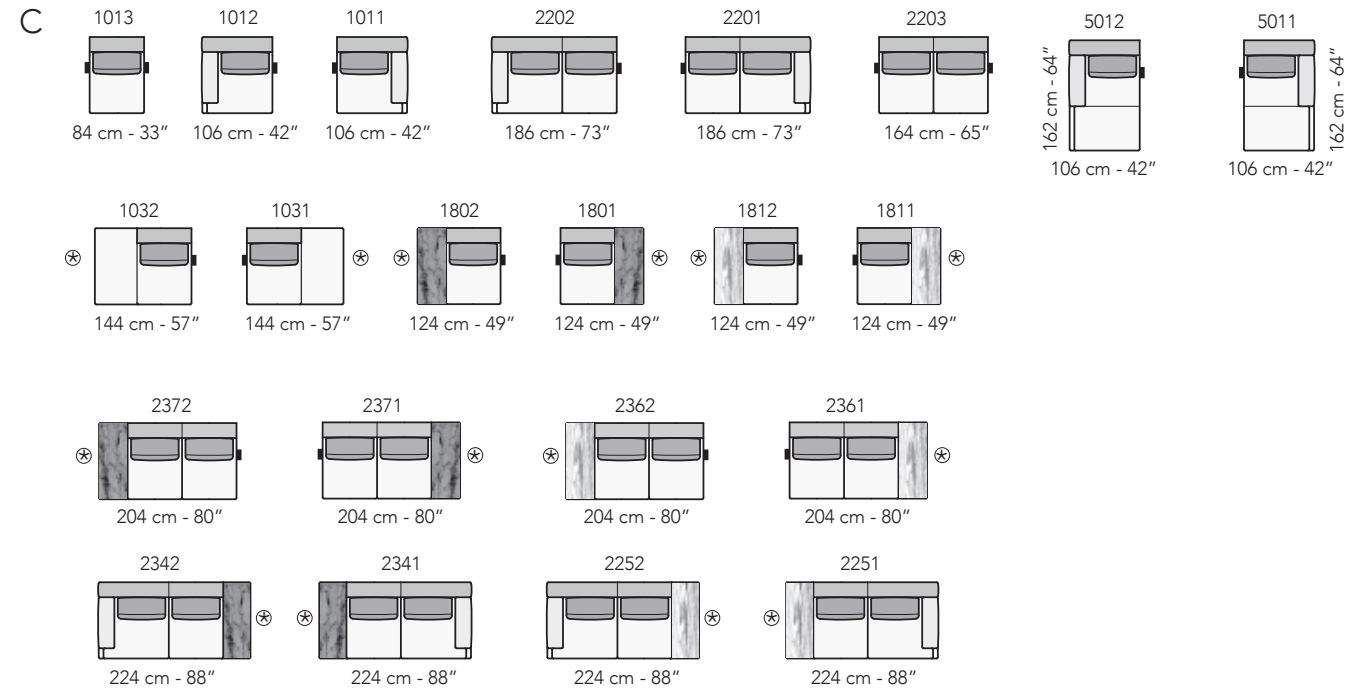

tutti gli elementi del gruppo C hanno lo stesso modulo di seduta - all items in group C have the same seat width

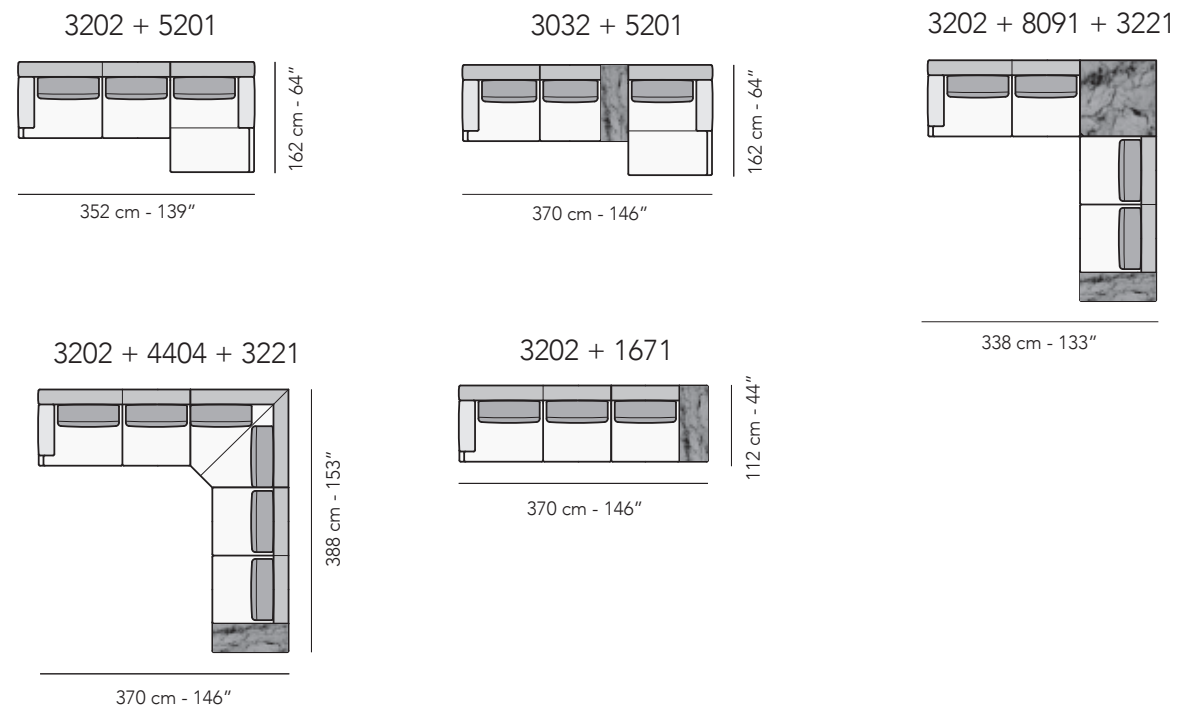
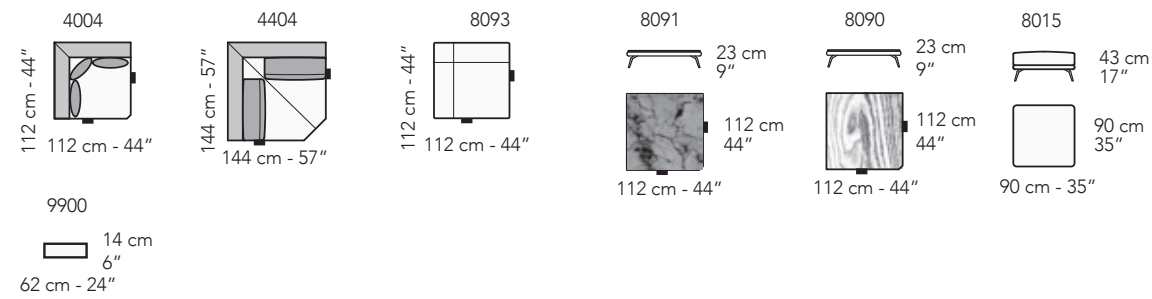

Composizioni consigliate - Recommended compositions

Legenda - Legend

- Spalliera / Back Cushions
- Poggiareni / Kidneyrest
- Bracciolo / Armrest
- Marmo / Marble
- Legno / Wood
- Aggancio Componibile / Connector
- Seduta / Seat Cushions
- ⊗ Sistema Sound
- \* Lato terminale sempre rifinito e agganciabile agli elementi componibili / Terminal side is always finished and it can also be connected to modular elements



# Brera

Design Application N° 402017000039849



frontale - front

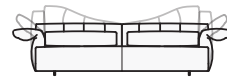

laterale - depth

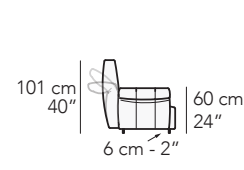
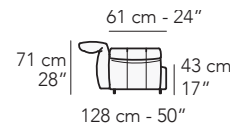

21 cm - 8"

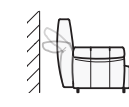

21 cm - 8"



## Caratteristiche standard

- Struttura in legno e multistrato, molleggio seduta con cinghie elastiche.
- Imbottitura in poliuretano espanso ecologico a cellula aperta con densità differenziate, rivestito da un materassino in misto piuma.
- Cuscinetto lombare in misto piuma.
- Rivestimento in pelle e tessuto. Tutti i rivestimenti sono fissi con cuscinetto lombare sfoderabile.
- Solo per il mercato ITALIA il rivestimento in tessuto è completamente sfoderabile.
- Braccioli e schienali dotati di meccanismo a snodo che si ripiega verso l'esterno.
- Piede in metallo Canna di fucile (Cod.50).
- Cucitura Cod.03 per rivestimento in pelle e tessuto.
- Cucitura Cod.06 per la seduta con rivestimento in pelle.
- Inserimento letto non possibile.
- Lato componibile rifinito.
- Per tutte le versioni i braccioli e gli schienali hanno un sistema a baionetta e sono removibili.

## Caratteristiche optional su richiesta senza maggiorazione

- Nessuna maggiorazione in caso di scelta del solo bordino a contrasto.
- Disponibile con cucitura a contrasto, per la scelta del colore fare riferimento ai codici del campionario pelli.

## Caratteristiche optional su richiesta con maggiorazione

- Per il multi rivestimento il prezzo va incrementato del 7%. Per maggiori dettagli fare riferimento al paragrafo "NOTE" posto nelle prime pagine del listino.

## Note

- Non è possibile applicare altre cuciture.
- I disegni grafici che riportano l'asterisco (\*) sono sempre con lato rifinito e anche agganciabili agli elementi componibili.

## Standard features

- Frame: wooden structure, seat suspensions in reinforced elastic webbing.
- Padding in eco-friendly open cell polyurethane foam, with different densities, covered with a mixed feather layer.
- Lumbar cushion in mixed feather.
- Covering in leather or fabric. Not removable coverings except for lumbar cushion.
- Armrests and back cushions with a chain-joints mechanism bending outwards.
- Metal legs in Gunmetal (Cod.50).
- Stitching type Cod.03 for coverings in fabric and leather.
- Stitching type Cod.06 for seat cushion in leather.
- No bed version available.
- Sectional sides finished.
- For all versions armrests and back cushions are attached via bayonet connectors system and can be removed.

## Optional features without any upcharge

- No upcharge for contrasting piping.
- Contrast stitching available. Please refer to our leather collection for a thread color indication.

## Optional features with upcharge

- 7% upcharge for combined coverings. Please refer to the notes at the beginning of pricelist.

## Notes

- Different stitchings not available.
- Versions with asterisk (\*) have always the finished terminal side with the possibility to be connected to modular elements.

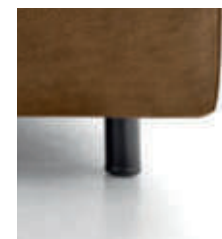

Piede in metallo // Metal Legs



Gunmetal

Cuciture // Stitching

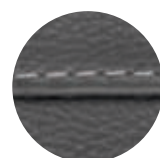

Cod.03

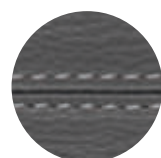

Cod.06

Tessuto // Fabric  
Pelle // Leather

## Versioni \ Versions

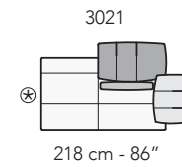
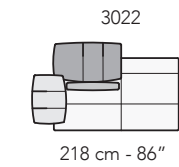
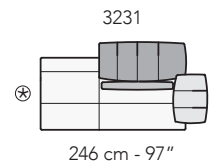
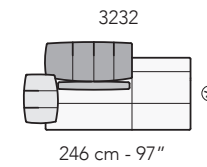
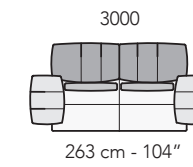
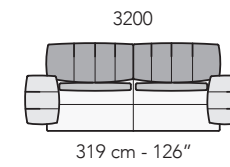

## A

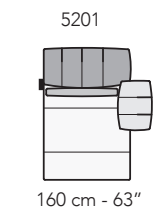
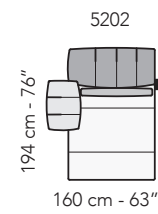
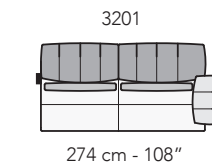
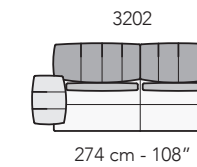
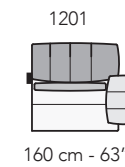
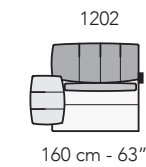
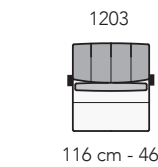

tutti gli elementi del gruppo A hanno lo stesso modulo di seduta - all items in group A have the same seat width

## B

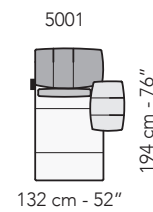
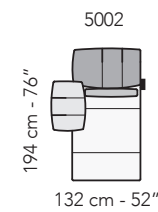
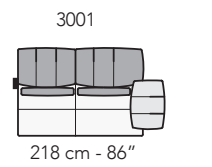
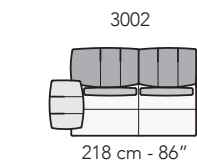
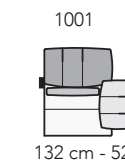
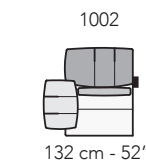
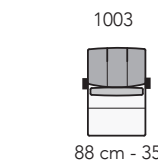

tutti gli elementi del gruppo B hanno lo stesso modulo di seduta - all items in group B have the same seat width

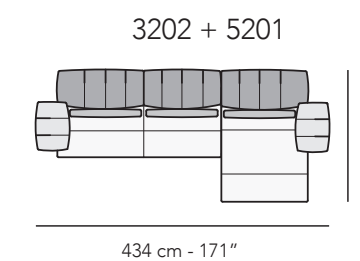
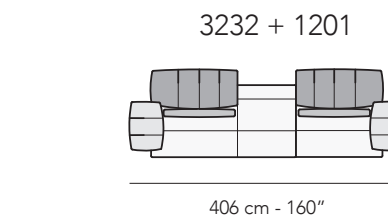
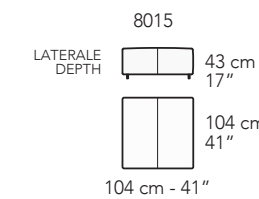

Composizioni consigliate - Recommended compositions

## Legenda - Legend

- Spalliera / Back Cushions
- Poggiatesta / Kidneyrest
- Bracciolo / Armrest
- Marmo / Marble
- Legno / Wood
- Aggancio Componibile / Connector

- Seduta / Seat Cushions
- Sistema Sound

\* Lato terminale sempre rifinito e agganciabile agli elementi componibili / Terminal side is always finished and it can also be connected to modular elements



# Bresso

Design Application N° 402017000039849

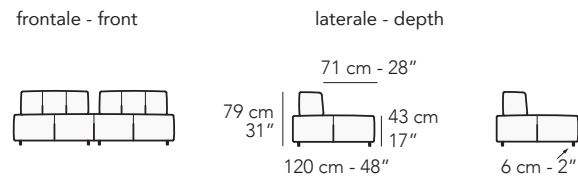

## Caratteristiche standard

- Struttura in legno e multistrato, molleggio seduta con cinghie elastiche.
- Imbottitura in poliuretano espanso ecologico a cellula aperta con densità differenziate, rivestito da un materassino in misto piuma.
- Rivestimento in pelle o tessuto. Tutti i rivestimenti sono fissi.
- Solo per il mercato ITALIA il rivestimento in tessuto è completamente sfoderabile.
- Schienali indipendenti posizionabili liberamente e resi stabili da una struttura interna in metallo.
- Piede in metallo Canna di fucile (Cod.50).
- Inserimento letto non possibile.
- Lato componibile rifinito.
- Cucitura Cod.03 per rivestimento in pelle e tessuto.
- Cucitura Cod.06 per parte superiore della seduta con rivestimento in pelle.

## Caratteristiche optional su richiesta senza maggiorazione

- Nessuna maggiorazione in caso di scelta del solo bordino a contrasto.
- Disponibile con cucitura a contrasto, per la scelta del colore fare riferimento ai codici del campionario pelli.

## Caratteristiche optional su richiesta con maggiorazione

- Per il multi rivestimento il prezzo va incrementato del 7%. Per maggiori dettagli fare riferimento al paragrafo "NOTE" posto nelle prime pagine del listino.

## Note

- Non è possibile applicare altre cuciture.

## Standard features

- *Frame: wooden structure, seat suspensions in reinforced elastic webbing.*
- *Padding in eco-friendly open cell polyurethane foam, with different densities, covered with a mixed feather layer.*
- *Covering in leather or fabric. Not removable coverings.*
- *Independent, freely movable back cushions, equipped with an internal metal structure.*
- *Metal legs in Gunmetal (Cod.50).*
- *No bed version available.*
- *Sectional sides finished.*
- *Stitching type Cod.03 for leather and fabric coverings.*
- *Stitching type Cod.06 for the top part of the seat cushion leather covering.*

## Optional features without any upcharge

- *No upcharge for contrasting piping.*
- *Contrast stitching available. Please refer to our leather collection for a thread color indication.*

## Optional features with upcharge

- *7% upcharge for combined coverings. Please refer to the notes at the beginning of pricelist.*

## Notes

- *Different stitchings not available.*

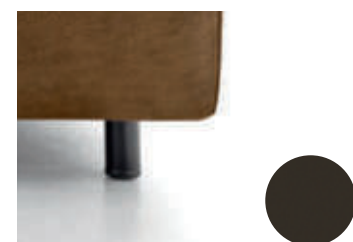

Piede in metallo // Metal Legs

Gunmetal

## Cuciture// Stitching

Tessuto  
Fabric  
Pelle  
Leather

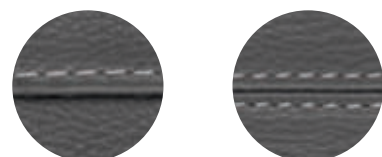

Cod.03

Cod.06

## Versioni \ Versions

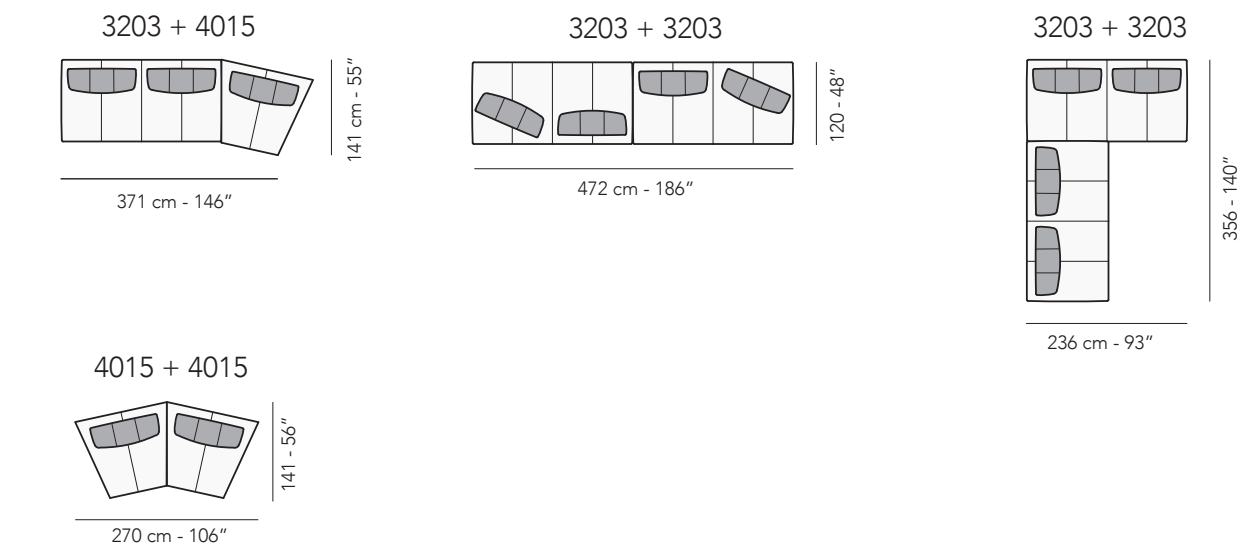
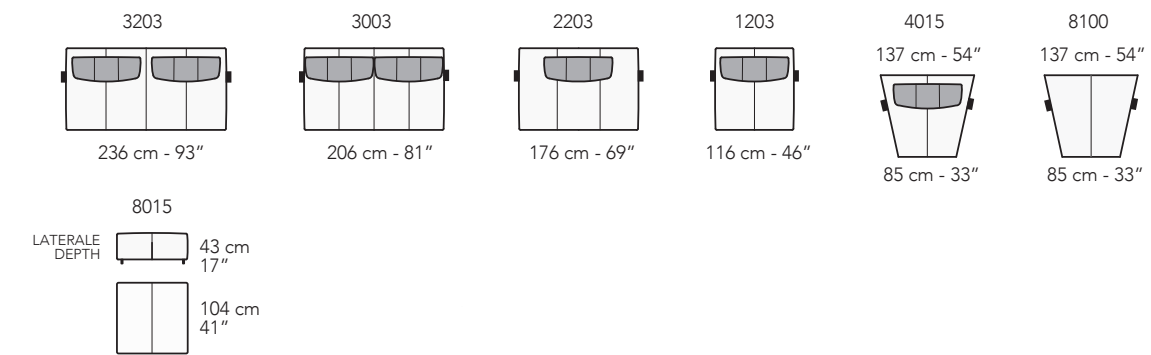

## Composizioni consigliate - Recommended compositions

## Legenda - Legend

- Spalliera / Back Cushions
- Poggiatesta / Kidneyrest
- Bracciolo / Armrest
- Marmo / Marble
- Legno / Wood
- Aggancio Componibile / Connector

- Seduta / Seat Cushions
- Sistema Sound

\* Lato terminale sempre rifinito e agganciabile agli elementi componibili / Terminal side is always finished and it can also be connected to modular elements



# Bresso Air

Design Application N° 402017000039849



frontale - front

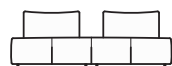

laterale - depth

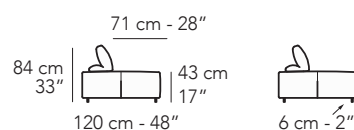

## Caratteristiche standard

- Struttura in legno e multistrato, molleggio seduta con cinghie elastiche.
- Imbottitura in poliuretano espanso ecologico a cellula aperta con densità differenziate, rivestito da un materassino in misto piuma.
- Rivestimento in pelle o tessuto. Tutti i rivestimenti sono fissi.
- Solo per il mercato ITALIA il rivestimento in tessuto è completamente sfoderabile.
- Schienali indipendenti posizionabili liberamente e resi stabili da una struttura interna in metallo.
- Piede in metallo Canna di fucile (Cod.50).
- Inserimento letto non possibile.
- Lato componibile rifinito.
- Cucitura Cod.06 per parte superiore della seduta con rivestimento in pelle.

## Caratteristiche optional su richiesta senza maggiorazione

- Nessuna maggiorazione in caso di scelta del solo bordino a contrasto.
- Disponibile con cucitura a contrasto, per la scelta del colore fare riferimento ai codici del campionario pelli.

## Caratteristiche optional su richiesta con maggiorazione

- Per il multi rivestimento il prezzo va incrementato del 7%. Per maggiori dettagli fare riferimento al paragrafo "NOTE" posto nelle prime pagine del listino.

## Note

- Non è possibile applicare altre cuciture.

## Standard features

- *Frame: wooden structure, seat suspensions in reinforced elastic webbing.*
- *Padding in eco-friendly open cell polyurethane foam, with different densities, covered with a mixed feather layer.*
- *Covering in leather or fabric. Not removable coverings.*
- *Independent, freely movable back cushions, equipped with an internal metal structure.*
- *Metal legs in Gunmetal (Cod.50).*
- *No bed version available.*
- *Sectional sides finished.*
- *Stitching type Cod.06 for the top part of the seat cushion covered in leather.*

## Optional features without any upcharge

- *No upcharge for contrasting piping.*
- *Contrast stitching available. Please refer to our leather collection for a thread color indication.*

## Optional features with upcharge

- *7% upcharge for combined coverings. Please refer to the notes at the beginning of pricelist.*

## Notes

- *Different stitchings not available.*



Piede in metallo // Metal Legs



Gunmetal

Cuciture// Stitching

Tessuto  
Fabric  
Pelle  
Leather

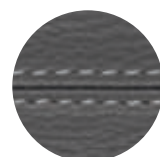

Cod.06

## Versioni \ Versions

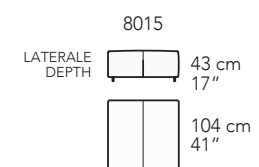
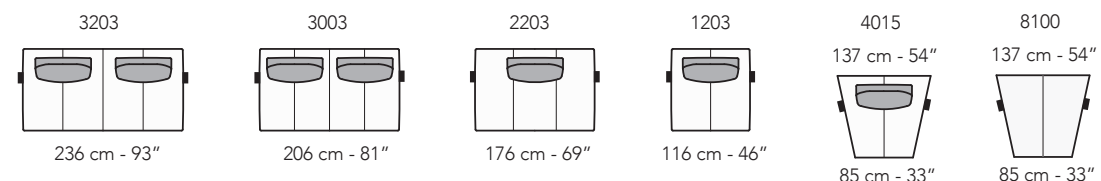

3203 + 4015

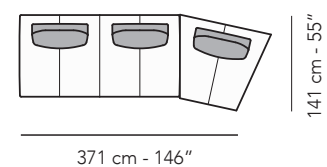

3203 + 3203

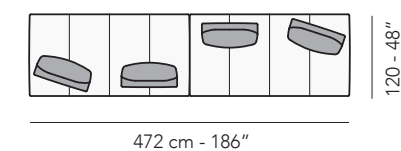

1203 + 4015 + 1203 + 4015

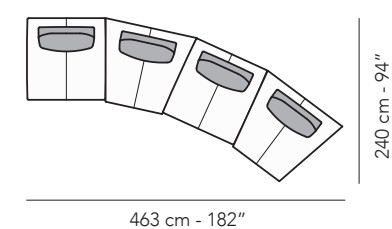

3203 + 3203

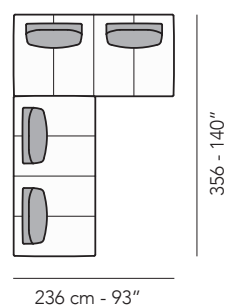

4015 + 4015

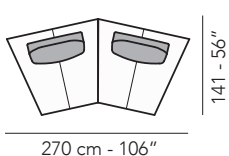

Composizioni consigliate - Recommended compositions

## Legenda - Legend

- Spalliera / Back Cushions
- Poggiareni / Kidneyrest
- Bracciolo / Armrest
- Marmo / Marble
- Legno / Wood
- Aggancio Componibile / Connector

- Seduta / Seat Cushions
- Sistema Sound

\* Lato terminale sempre rifinito e agganciabile agli elementi componibili / Terminal side is always finished and it can also be connected to modular elements



# Bric



frontale - front

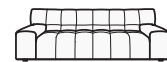

laterale - depth

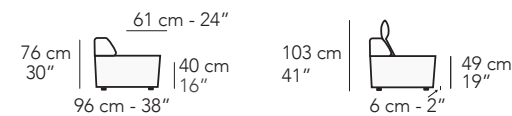

## Caratteristiche standard

- Struttura in legno e multistrato, molleggio seduta e schienale con cinghie elastiche.
- Imbottitura in poliuretano espanso ecologico a cellula aperta con densità differenziate, rivestito da falda di Tecnoform accoppiata al rivestimento esterno.
- Rivestimento in pelle o tessuto. Tutti i rivestimenti sono fissi.
- Piedi in materiale termoplastico nero.
- Inserimento letto non possibile.
- Lato componibile rifinito.

## Caratteristiche optional su richiesta con maggiorazione

- Vassoio sopra bracciolo in plexiglass trasparente.
- Poggiatesta (Cod.9900) con struttura in metallo e imbottitura in poliuretano espanso ecologico a cellula aperta.
- Per il multi rivestimento il prezzo va incrementato del 7%. Per maggiori dettagli fare riferimento al paragrafo "NOTE" posto nelle prime pagine del listino.

## Note

- Non è possibile applicare cuciture sui rivestimenti in pelle e tessuto.

## Standard features

- *Frame: wooden structure, seat suspensions in reinforced elastic webbing.*
- *Padding in eco-friendly open cell polyurethane foam, with different densities, covered with a Tecnoform layer.*
- *Covering in leather or fabric. Not removable coverings.*
- *Legs in black thermoplastic material.*
- *No bed version available.*
- *Finished sectional sides.*

## Optional features with upcharge

- *Plexiglass armrest tray.*
- *Headrest (Cod.9900) with metal structure and padding in eco-friendly open cell polyurethane foam.*
- *7% upcharge for combined coverings. Please refer to the notes at the beginning of pricelist.*

## Notes

- *No stitchings available for leather or fabric.*

## Versioni \ Versions

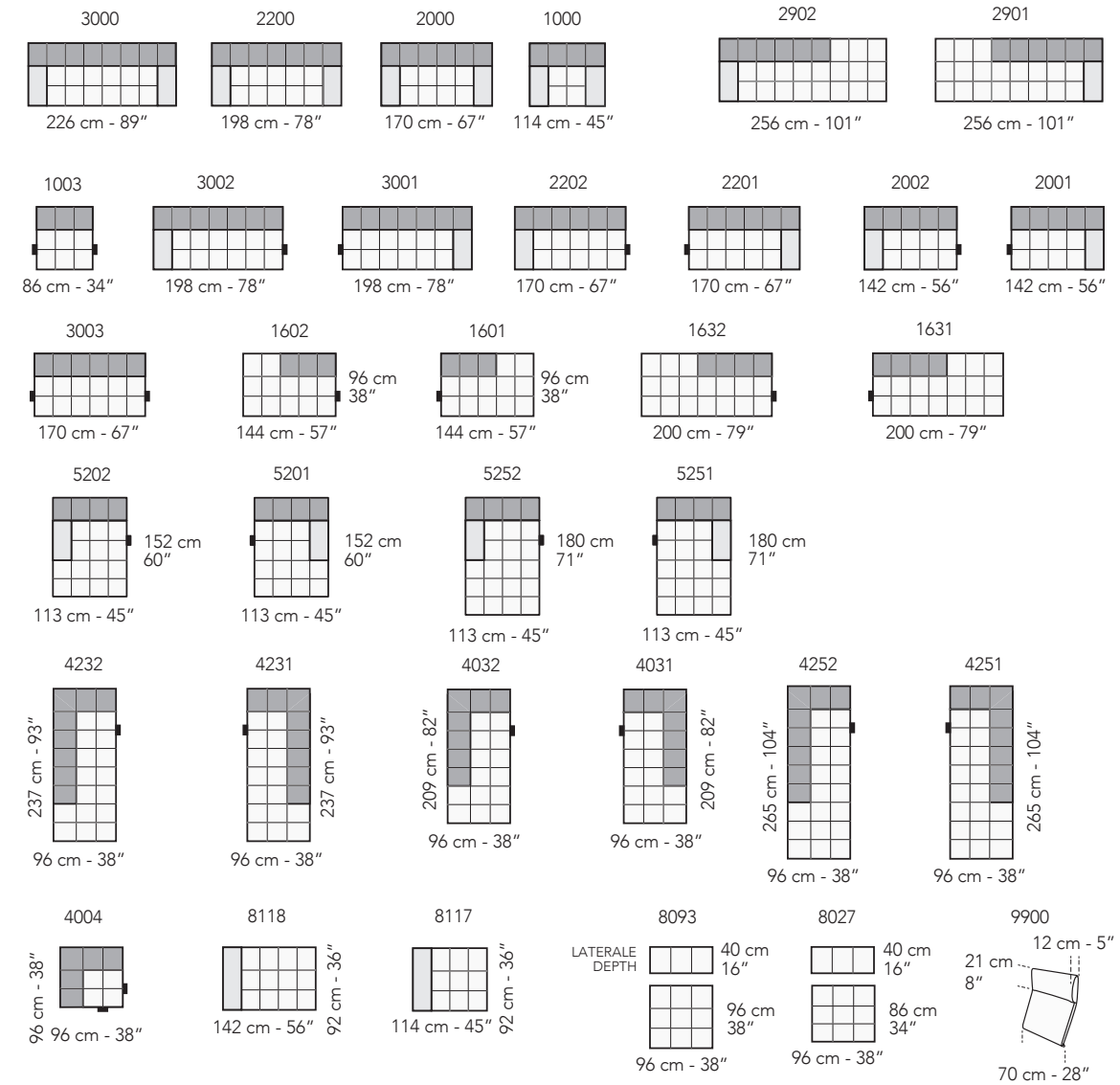

3002 + 5251

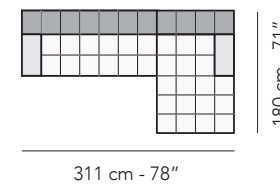

3002 + 1003 + 4231

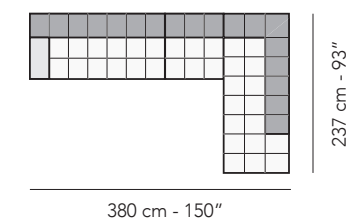

## Composizioni consigliate - Recommended compositions

## Legenda - Legend

- Spalliera / Back Cushions
- Poggiareni / Kidneyrest
- Bracciolo / Armrest
- Marmo / Marble
- Legno / Wood
- Aggancio Componibile / Connector

- Seduta / Seat Cushions
- Ⓢ Sistema Sound

\* Lato terminale sempre rifinito e agganciabile agli elementi componibili / Terminal side is always finished and it can also be connected to modular elements



# Cadorna

design application n° 402018000002313



frontale - front

laterale - depth

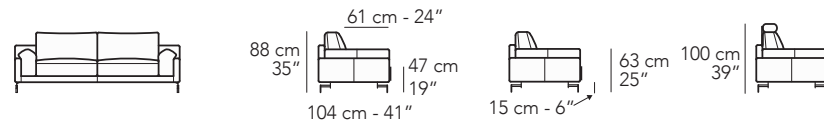

## Caratteristiche standard

- Struttura in legno e multistrato con supporto in metallo, molleggio seduta con cinghie elastiche.
- Cuscini di seduta con doppia densità poliuretano espanso ecologico a cellula aperta e memory foam rivestito da un materassino in piuma.
- Cuscini di spalliera in fibra "Extra soft" e inserto in poliuretano espanso ecologico a cellula aperta.
- Cuscini di bracciolo in fibra "Extra soft".
- Rivestimento in pelle o tessuto con cuscini di seduta, spalliera e braccioli sfoderabili.
- Solo per il mercato ITALIA il rivestimento in tessuto è completamente sfoderabile.
- Piede in metallo Lucido (Cod.30), Satinato (Cod.31), Canna di fucile (Cod.50), Ottone satinato (Cod.51) e verniciati nei colori RAL opaco: RAL 7006 - RAL 7024 - RAL 7044 - RAL 8019 - RAL 9016.
- Elementi Cod.1431 - 1432 - 1461 - 1462 - 1681 - 1682 - 1721 - 1722 - 2251 - 2252 - 2361 - 2362 - 3041 - 3042 - 3061 - 3062 con ripiano in legno Noce canaletto (Cod.10).
- Elementi Cod.1421 - 1422 - 1471 - 1472 - 1671 - 1672 - 1731 - 1732 - 2341 - 2342 - 2371 - 2372 - 3031 - 3032 - 3051 - 3052 con ripiano in marmo Emperador (Cod.EM) oppure marmo bianco Carrara (Cod.CA).
- Cucitura Cod.03 per rivestimento in pelle e tessuto.
- Inserimento letto non possibile.
- Lato componibile rifinito.

## Caratteristiche optional su richiesta senza maggiorazione

- Disponibile con cucitura a contrasto, per la scelta del colore fare riferimento ai codici del campionario pelli.

## Caratteristiche optional su richiesta con maggiorazione

- Tavolino terminale (Cod.9503) fissato alla struttura e con ripiano in legno Noce canaletto (Cod.10), marmo Emperador (Cod.EM) oppure marmo Carrara (Cod.CA), disponibile per gli elementi Cod.1041 - 1042 - 1091 - 1092 - 1661 - 1662 - 1841 - 1842 - 5253.
- Poggiatesta (Cod.9900) con imbottitura in poliuretano espanso e supporto in metallo rivestito.
- Per il multi rivestimento il prezzo va incrementato del 7%. Per maggiori dettagli fare riferimento al paragrafo "NOTE" posto nelle prime pagine del listino.

## Note

- Non è possibile applicare altre cuciture.
- Gli elementi Cod.4004 - 4051 - 4052 - 8129 possono essere utilizzati indifferentemente con i gruppi A - B.
- I disegni grafici che riportano l'asterisco (\*) sono sempre con lato rifinito e anche agganciabili agli elementi componibili.



Piede in metallo // Metal Legs

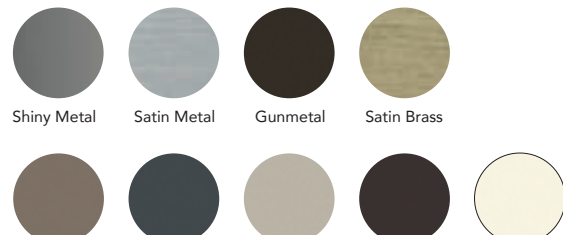

Ral 7006 Ral 7024 Ral 7044 Ral 8019 Ral 9016



Elementi // Versions

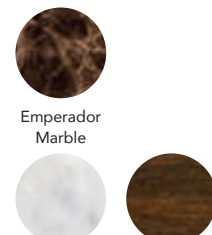

White Carrara Marble Canaletto Walnut

Cuciture // Stitching

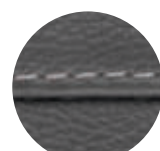

Tessuto // Fabric  
Pelle // Leather

Cod.03

## Standard features

- Frame: wooden structure with metal support, seat suspensions in reinforced elastic webbing.
- Seat cushions with double density in open cell polyurethane foam and memory foam covered with a feather layer.
- Back cushions in "Extra soft" fiber with eco-friendly open cell polyurethane foam.
- Armrest cushions in "Extra soft" fiber.
- Covering in leather or fabric. Seat, back and armrest cushions coverings removable.
- Legs in Shiny metal (Cod.30), Satin (Cod.31), Gunmetal (Cod.50), Satin brass (Cod.51) and painted in matte finished RAL colors: RAL 7006 - RAL 7024 - RAL7044 - RAL 8019 - RAL 9016.
- Versions Cod.1431 - 1432 - 1461 - 1462 - 1681 - 1682 - 1721 - 1722 - 2251 - 2252 - 2361 - 2362 - 3041 - 3042 - 3061 - 3062 with wooden top in Canaletto walnut (Cod.10).
- Versions Cod.1421- 1422- 1471- 1472- 1671 - 1672 - 1731 - 1732 - 2341- 2342- 2371- 2372 - 3031- 3032- 3051- 3052 with top in marble Emperador (Cod.EM) or Carrara white marble (Cod.CA).
- Stitching type Cod.03 for leather and fabric coverings.
- No bed version available.
- Sectional sides finished.

## Optional features without any upcharge

- Contrast stitching available. Please refer to our leather collection for a thread color indication.

## Optional features with upcharge

- Terminal table (Cod.9503) attached to the frame, with the top available in wood in Canaletto walnut (Cod.10), Emperador marble (Cod.EM) or Carrara white marble (Cod. CA) on versions Cod.1041 - 1042 - 1091 - 1092 - 1661 - 1662 - 1841 - 1842 - 5253.
- Headrest (Cod.9900) with padding in open cell polyurethane foam and covered metal structure.
- 7% upcharge for combined coverings. Please refer to the notes at the beginning of pricelist.

## Notes

- Different stitchings not available.
- Versions Cod.4004 - 4051 - 4052 - 8129 can be used with groups A - B - C.
- Versions with asterisk (\*) have always the finished terminal side with the possibility to be connected to modular elements.

## Versioni \ Versions

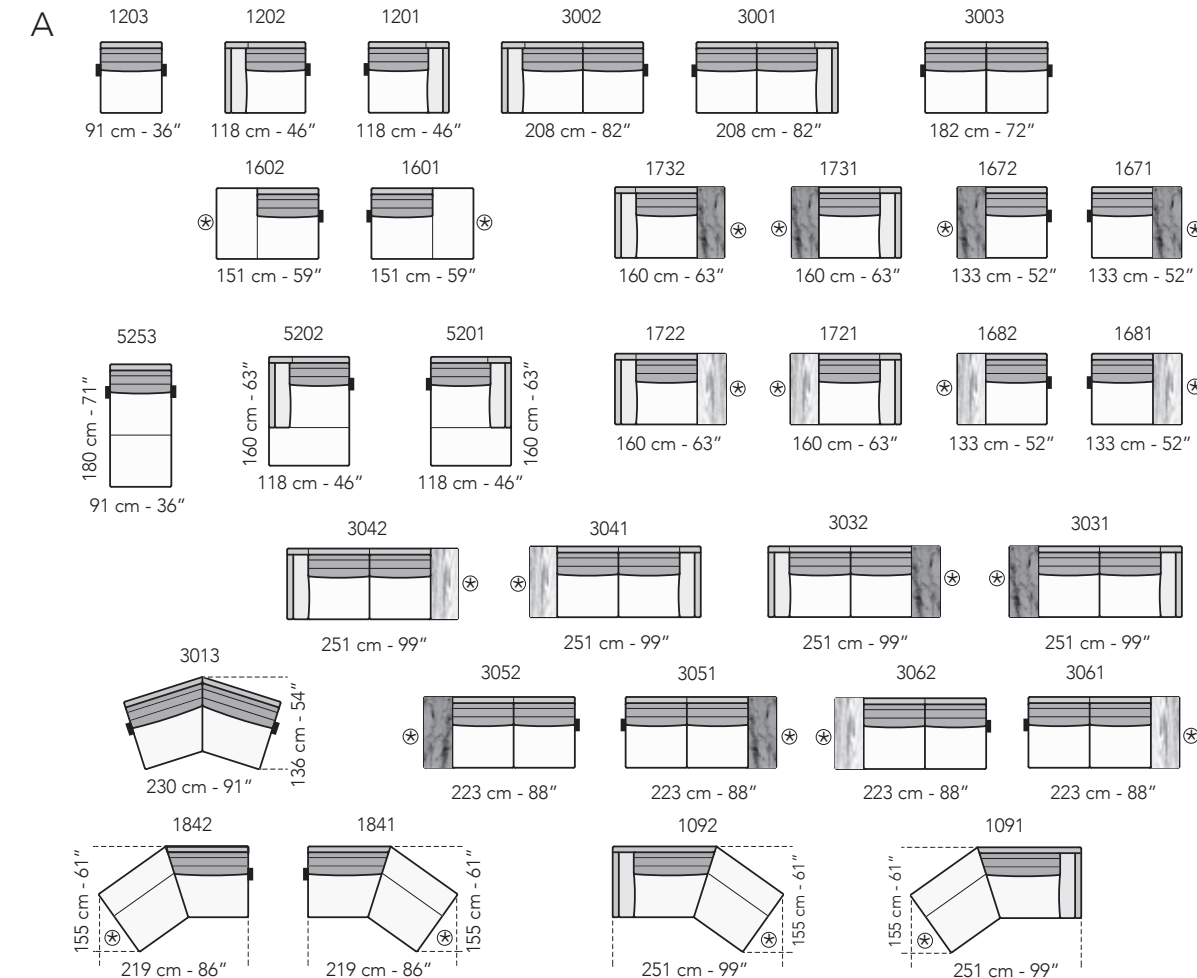
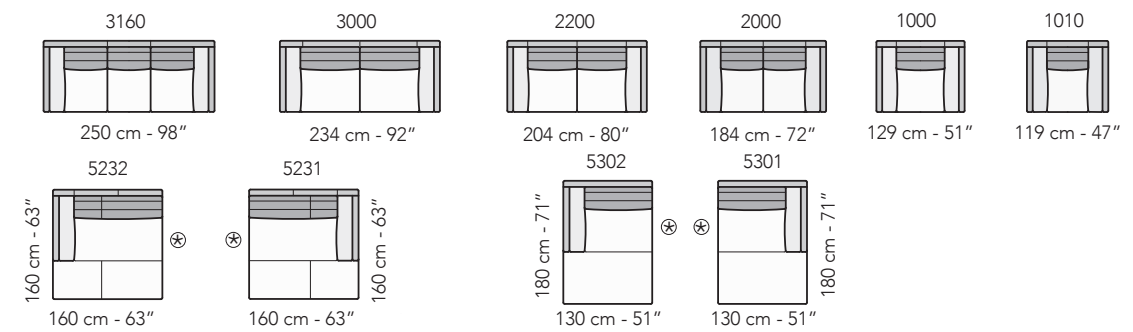

tutti gli elementi del gruppo A hanno lo stesso modulo di seduta - all items in group A have the same seat width



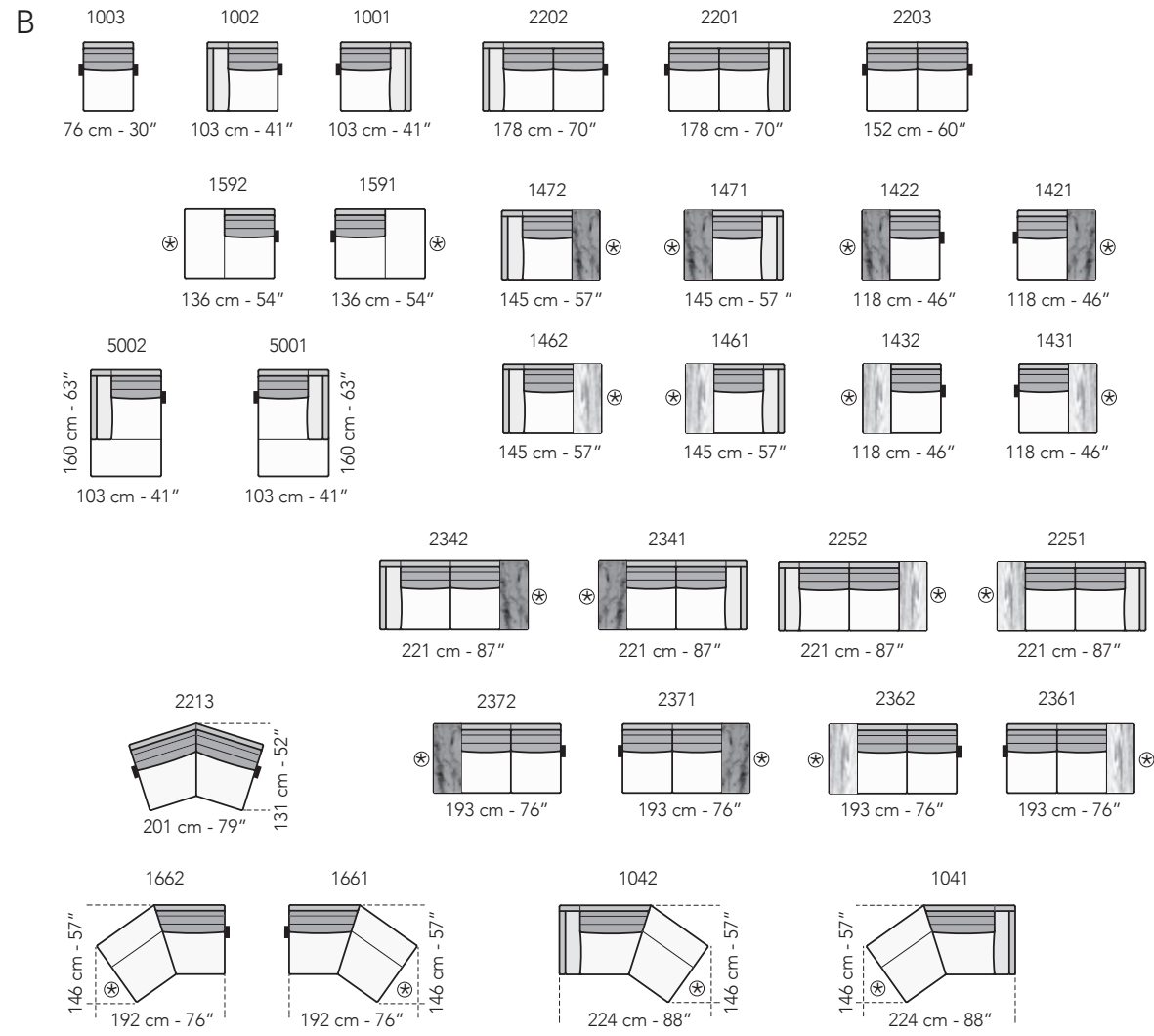

tutti gli elementi del gruppo B hanno lo stesso modulo di seduta - all items in group B have the same seat width

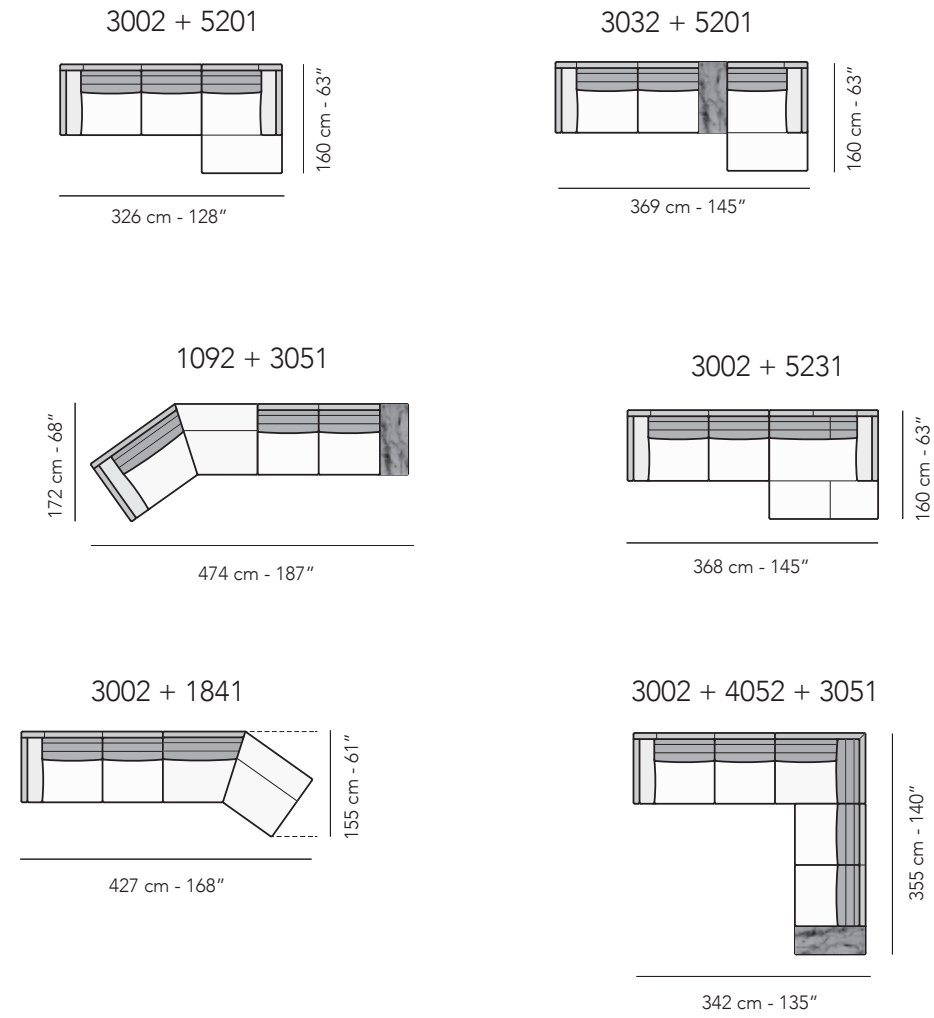
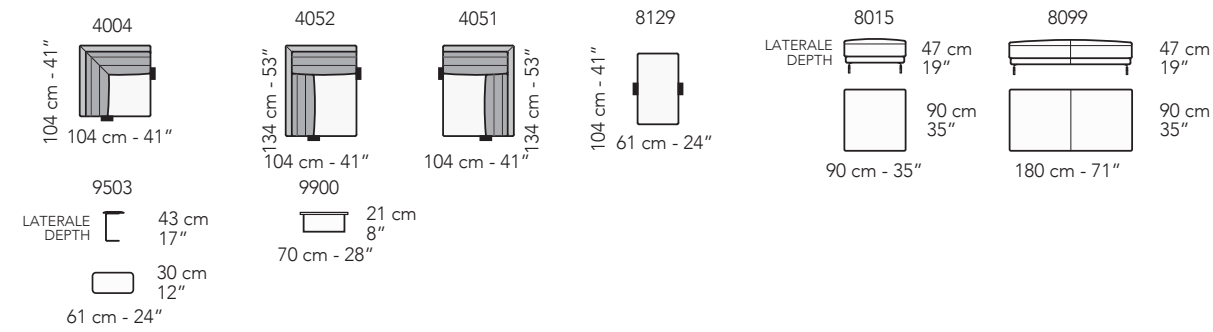

Composizioni consigliate - Recommended compositions

Legenda - Legend

- Spalliera / Back Cushions
- Poggiareni / Kidneyrest
- Bracciolo / Armrest
- Marmo / Marble
- Legno / Wood
- Aggancio Componibile / Connector
- Seduta / Seat Cushions
- Ⓢ Sistema Sound
- \* Lato terminale sempre rifinito e agganciabile agli elementi componibili / Terminal side is always finished and it can also be connected to modular elements



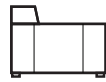

# Cairolì

design application N° 40201900000467



frontale - front



laterale - depth

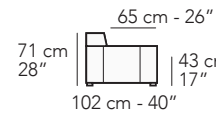

laterale br big - big arm depth



### Caratteristiche standard

- Struttura in legno e multistrato, molleggio seduta con cinghie elastiche.
- Imbottitura in poliuretano espanso ecologico a cellula aperta con densità differenziate, rivestito da un materassino in misto piuma.
- Rivestimento in pelle o tessuto. Tutti i rivestimenti sono fissi.
- Solo per il mercato ITALIA il rivestimento in tessuto è completamente sfoderabile.
- Piedi in materiale termoplastico nero.
- (\*) Cucitura Cod.04 per rivestimento in pelle e tessuto.
- Cucitura Cod.06 sulla parte superiore della seduta e parte posteriore bracciolo solo per rivestimento in pelle.
- Inserimento letto non possibile.
- Lato componibile rifinito.
- Per tutte le versioni in tessuto sfoderabile i braccioli solo removibili con sistema a baionetta.

### Caratteristiche optional su richiesta senza maggiorazione

- Disponibile con cucitura a contrasto, per la scelta del colore fare riferimento ai codici del campionario pelli.

### Caratteristiche optional su richiesta con maggiorazione

- Poggiatesta (Cod.9900) con imbottitura in poliuretano espanso e supporto in metallo rivestito.
- Per il multi rivestimento il prezzo va incrementato del 7%. Per maggiori dettagli fare riferimento al paragrafo "NOTE" posto nelle prime pagine del listino.

### Note

- (\*) Non è possibile realizzare il rivestimento con pelli di spessore maggiore di 1.8 mm, tra cui l'articolo Nobile.
- Gli elementi Cod.4004 - 4051 - 4052 possono essere utilizzati indifferentemente con i gruppi A - B.
- L'elemento Cod.8027 può essere utilizzato come modulo centrale all'interno della composizione indifferentemente con i gruppi A - B.
- Gli elementi Cod.6021 - 6022 sono versioni singole che non possono essere agganciate ad un elemento componibile.
- I disegni grafici che riportano l'asterisco (\*) sono sempre con lato rifinito e anche agganciabili agli elementi componibili.

### Standard features

- *Frame: wooden structure, seat suspensions in reinforced elastic webbing.*
- *Padding in eco-friendly open cell polyurethane foam, with different densities, covered with a mixed feather layer.*
- *Covering in leather or fabric. Not removable coverings.*
- *Legs in black thermoplastic material.*
- *(\*) Stitching type Cod.04 for leather and fabric coverings.*
- *Stitching type Cod.06 on the top part of the seat and the back part of the armrest only for leather covering.*
- *No bed version available.*
- *Sectional sides finished.*
- *Versions with removable fabric covering are equipped with bayonet connectors for armrests only.*

### Optional features without any upcharge

- *Contrast stitching available. Please refer to our leather collection for a thread color indication.*

### Optional features with upcharge

- *Headrest (Cod.9900) with padding in open cell polyurethane foam and covered metal structure.*
- *7% upcharge for combined coverings. Please refer to the notes at the beginning of pricelist.*

### Notes

- (\*) *Covering not available with leathers thicker than 1.8 mm, such as leather Nobile.*
- *Versions Cod.4004 - 4051 - 4052 can be used with groups A - B.*
- *Version Cod.8027 can be used as a central piece with groups A - B.*
- *Versions Cod.6021 - 6022 are free-standing and cannot be attached to modular elements.*
- *Versions with asterisk (\*) have always the finished terminal side with the possibility to be connected to modular elements.*

Cuciture//  
Stitching

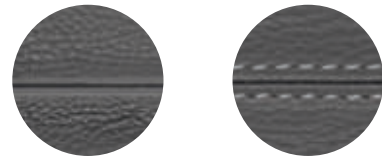

Cod.04

Cod.06

Poggiatesta//  
Headrest



### Versioni \ Versions

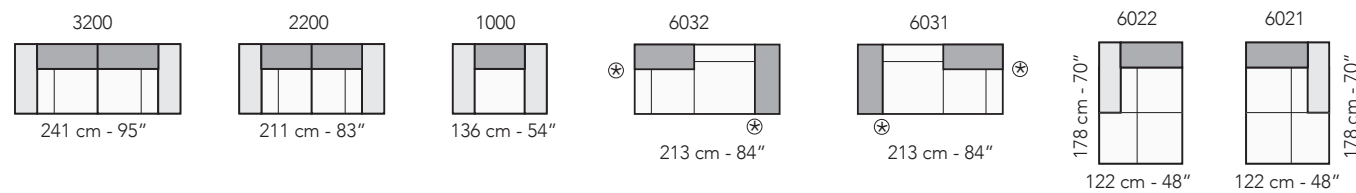

### Versioni \ Versions

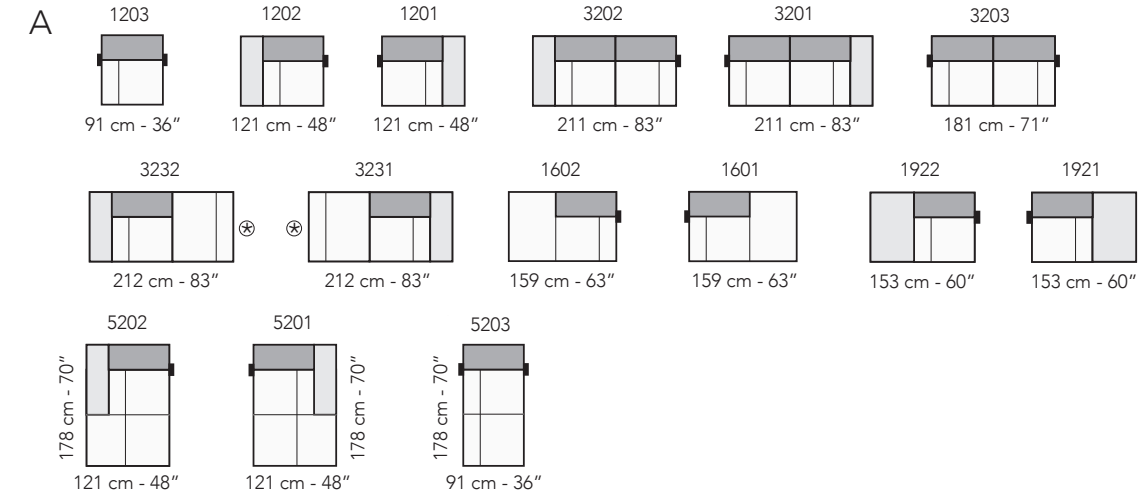

tutti gli elementi del gruppo A hanno lo stesso modulo di seduta - all items in group A have the same seat width

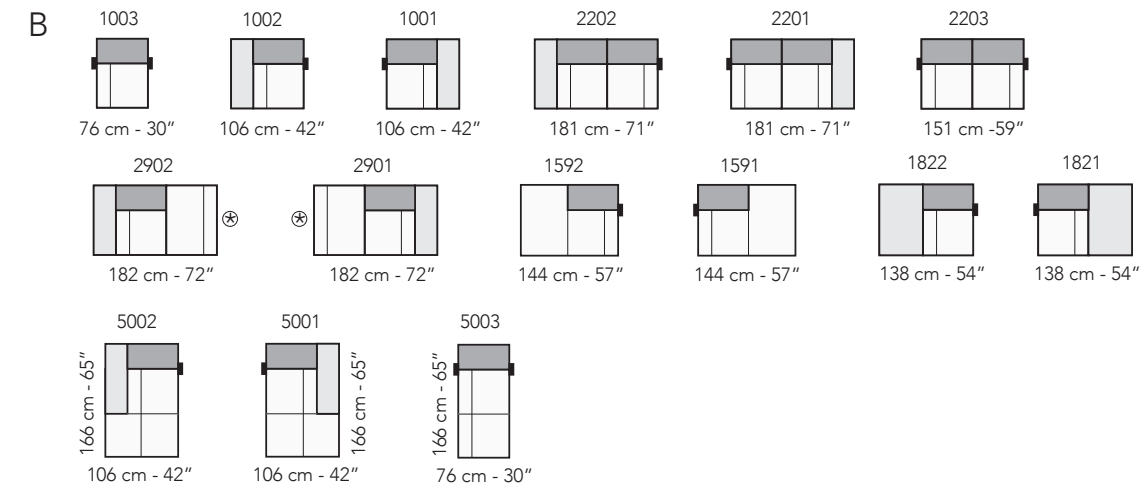

tutti gli elementi del gruppo B hanno lo stesso modulo di seduta - all items in group B have the same seat width

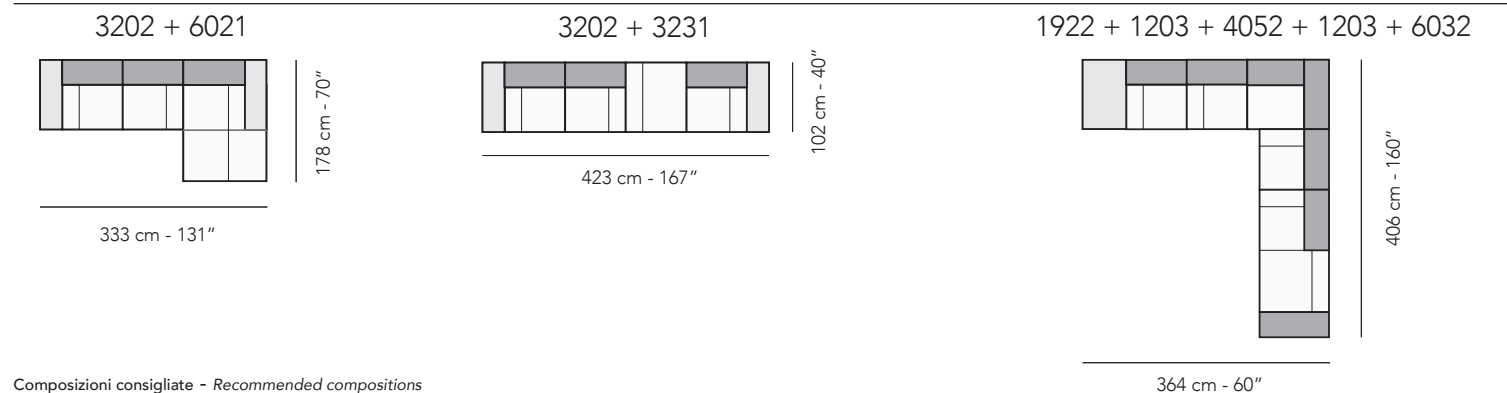
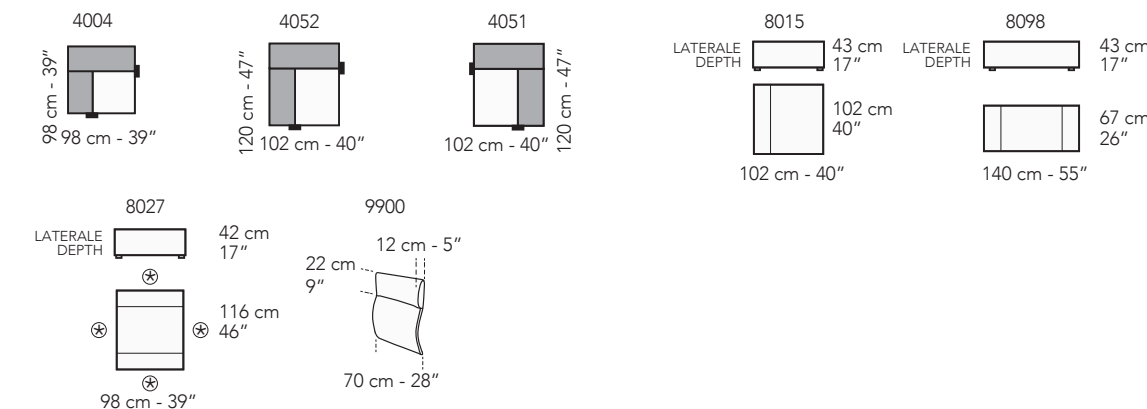

Composizioni consigliate - Recommended compositions

### Legenda - Legend

- Spalliera / Back Cushions
- Poggiaresi / Kidneyrest
- Bracciolo / Armrest
- Marmo / Marble
- Legno / Wood
- Aggancio Componibile / Connector

- Seduta / Seat Cushions
- Sistema Sound

\* Lato terminale sempre rifinito e agganciabile agli elementi componibili / Terminal side is always finished and it can also be connected to modular elements



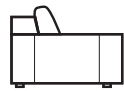

# Cairoli Deep



frontale - front



laterale - depth

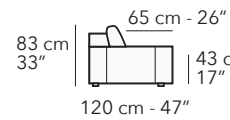

laterale br big - big arm depth



schede tecniche

### Caratteristiche standard

- Struttura in legno e multistrato, molleggio seduta con cinghie elastiche.
- Imbottitura in poliuretano espanso ecologico a cellula aperta con densità differenziate, rivestito da un materassino in misto piuma.
- Cuscino di spalliera removibile in misto piuma.
- Rivestimento in pelle o tessuto. Tutti i rivestimenti sono fissi, con cuscino di spalliera sfoderabile.
- Solo per il mercato ITALIA il rivestimento in tessuto è completamente sfoderabile.
- Piedi in materiale termoplastico nero.
- (\*) Cucitura Cod.04 per rivestimento in pelle e tessuto.
- Cucitura Cod.06 sulla parte superiore della seduta e parte posteriore bracciolo solo per rivestimento in pelle.
- Inserimento letto non possibile.
- Lato componibile rifinito.
- Per tutte le versioni in tessuto sfoderabile i braccioli solo removibili con sistema a baionetta.

### Caratteristiche optional su richiesta senza maggiorazione

- Disponibile con cucitura a contrasto, per la scelta del colore fare riferimento ai codici del campionario pelli.

### Caratteristiche optional su richiesta con maggiorazione

- Per il multi rivestimento il prezzo va incrementato del 7%. Per maggiori dettagli fare riferimento al paragrafo "NOTE" posto nelle prime pagine del listino.

### Note

- (\*) Non è possibile realizzare il rivestimento con pelli di spessore maggiore di 1.8 mm, tra cui l'articolo Nobile.
- Gli elementi Cod.D4004 - D4051 - D4052 possono essere utilizzati indifferentemente con i gruppi A - B.
- L'elemento Cod.D8027 può essere utilizzato come modulo centrale indifferentemente con i gruppi A - B.
- Gli elementi Cod.D6021 - D6022 sono versioni singole che non possono essere agganciate ad un elemento componibile.
- I disegni grafici che riportano l'asterisco (\*) sono sempre con lato rifinito e anche agganciabili agli elementi componibili.

### Standard features

- Frame: wooden structure, seat suspensions in reinforced elastic webbing.
- Padding in eco-friendly open cell polyurethane foam, with different densities, covered with a mixed feather layer.
- Back cushions with padding in mixed feather. Cushions are removable.
- Covering in leather or fabric. Not removable coverings except for back cushions coverings.
- Legs in black thermoplastic material.
- (\*) Stitching type Cod.04 for leather and fabric coverings.
- Stitching type Cod.06 on the top part of the seat and the back part of the armrest only for leather covering.
- No bed version available.
- Sectional sides finished.
- Versions with removable fabric covering are equipped with bayonet connectors for armrests only.

### Optional features without any upcharge

- Contrast stitching available. Please refer to our leather collection for a thread color indication.

### Optional features with upcharge

- 7% upcharge for combined coverings. Please refer to the notes at the beginning of pricelist.

### Notes

- (\*) Covering not available with leathers thicker than 1.8 mm, such as leather Nobile.
- Versions Cod.D4004 - D4051 - D4052 can be used with groups A - B.
- Version Cod.D8027 can be used as a central piece with groups A - B.
- Versions Cod.D6021 - D6022 are free-standing and cannot be attached to modular elements.
- Versions with asterisk (\*) have always the finished terminal side with the possibility to be connected to modular elements.

Cuciture//  
Stitching

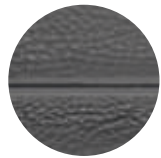

Cod.04

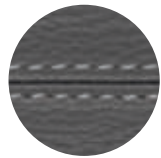

Cod.06

Tessuto  
Fabric  
Pelle  
Leather

### Versioni \ Versions

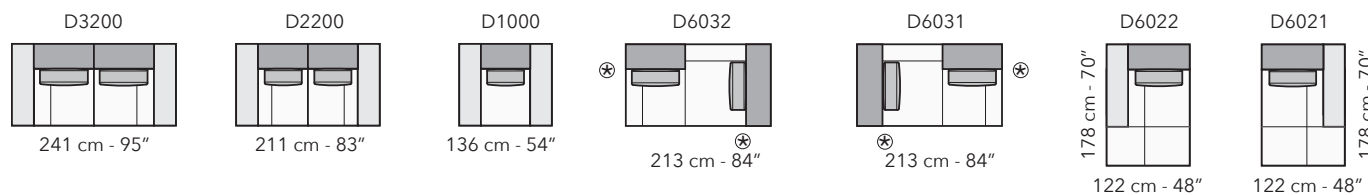

### Versioni \ Versions

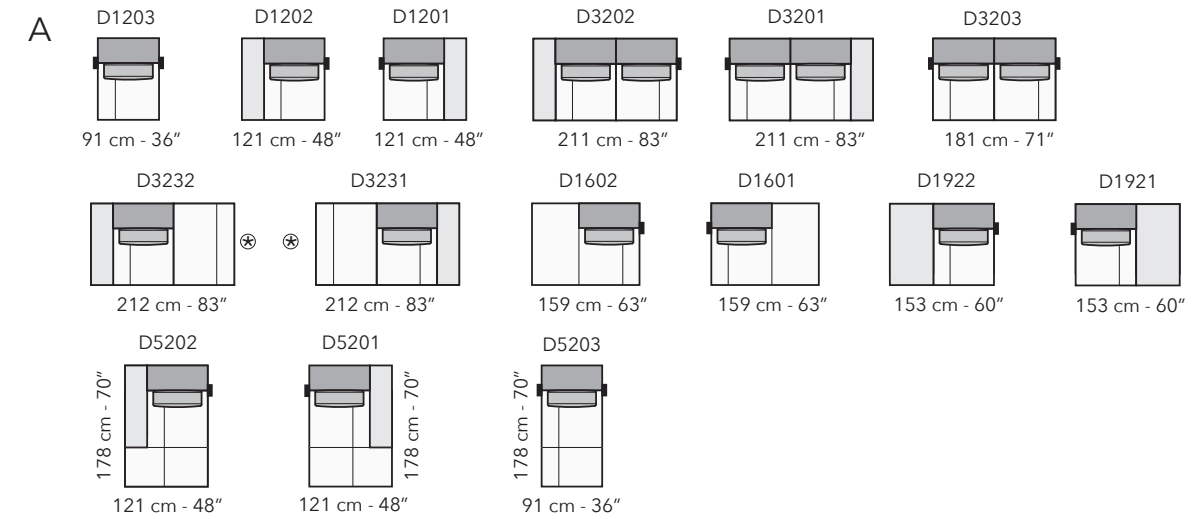

tutti gli elementi del gruppo A hanno lo stesso modulo di seduta - all items in group A have the same seat width

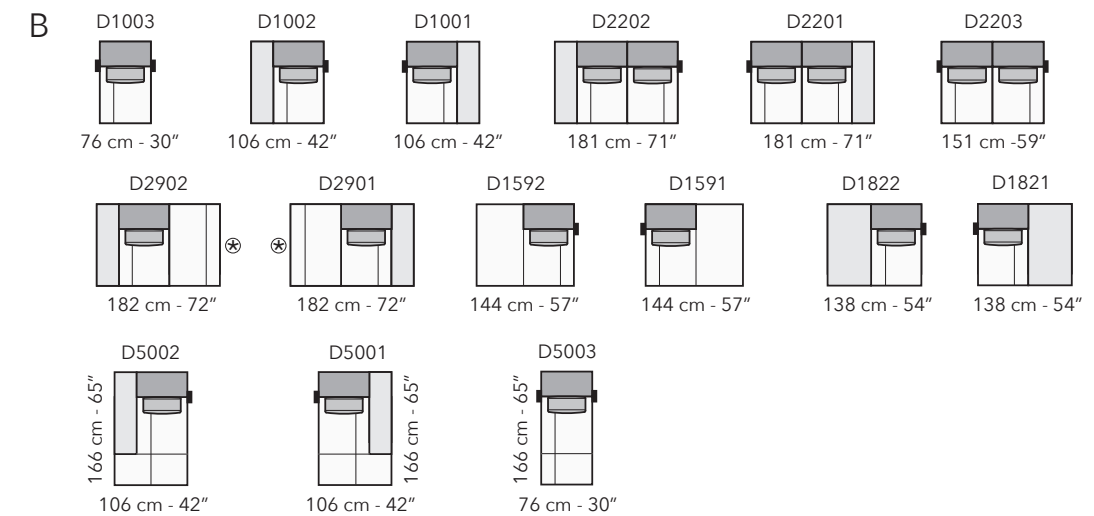

tutti gli elementi del gruppo B hanno lo stesso modulo di seduta - all items in group B have the same seat width

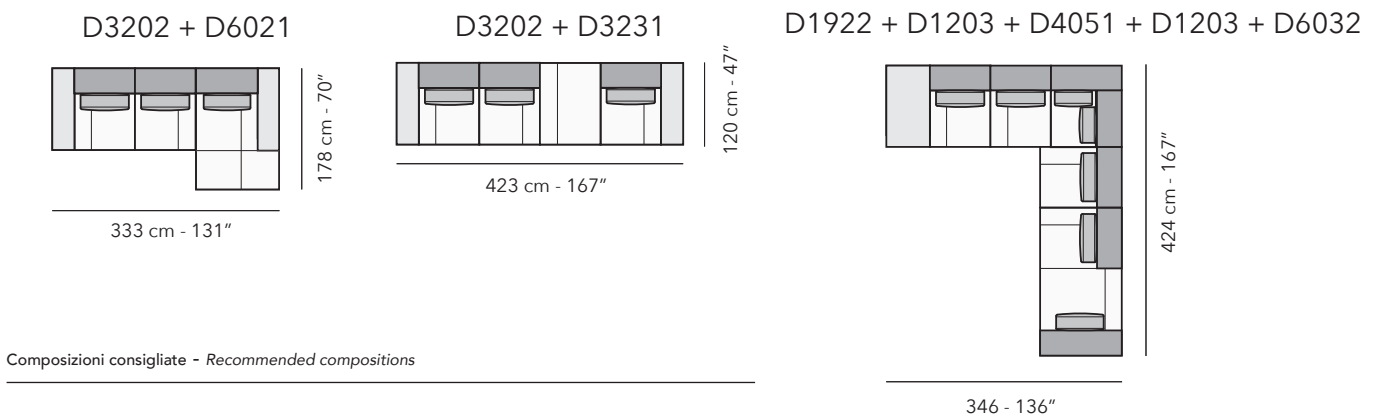
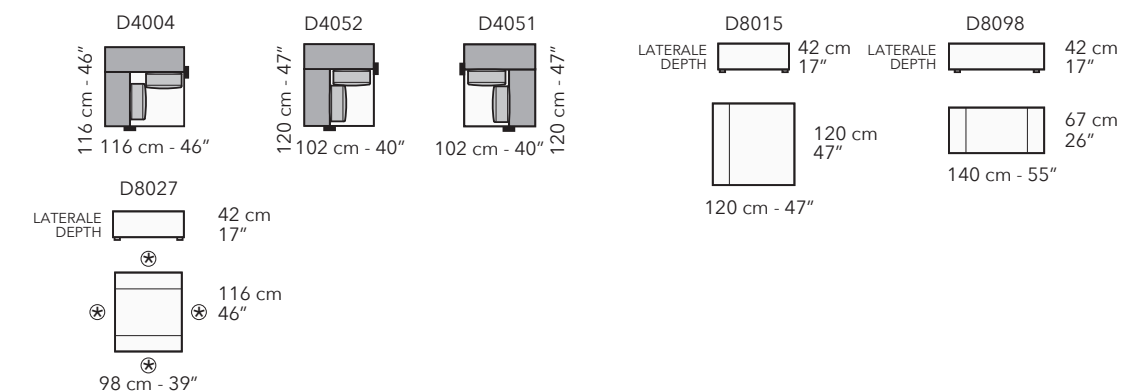

Composizioni consigliate - Recommended compositions

### Legenda - Legend

- Spalliera / Back Cushions
- Poggiatesta / Kidneyrest
- Bracciolo / Armrest
- Marmo / Marble
- Legno / Wood
- Aggancio Componibile / Connector

- Seduta / Seat Cushions
- Sistema Sound

\* Lato terminale sempre rifinito e agganciabile agli elementi componibili / Terminal side is always finished and it can also be connected to modular elements

technical sheet



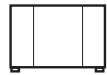

# Cairoli High



frontale - front



laterale - depth

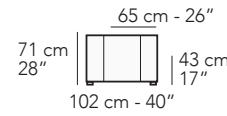

laterale br big - big arm depth



### Caratteristiche standard

- Struttura in legno e multistrato, molleggio seduta con cinghie elastiche.
- Imbottitura in poliuretano espanso ecologico a cellula aperta con densità differenziate, rivestito da un materassino in misto piuma.
- Rivestimento in pelle o tessuto. Tutti i rivestimenti sono fissi.
- Solo per il mercato ITALIA il rivestimento in tessuto è completamente sfoderabile.
- Piedi in materiale termoplastico nero.
- (\*) Cucitura Cod.04 per rivestimento in pelle e tessuto.
- Cucitura Cod.06 sulla parte superiore della seduta e parte posteriore bracciolo solo per rivestimento in pelle.
- Inserimento letto non possibile.
- Lato componibile rifinito.
- Per tutte le versioni in tessuto sfoderabile i braccioli solo removibili con sistema a baionetta.

### Caratteristiche optional su richiesta senza maggiorazione

- Disponibile con cucitura a contrasto, per la scelta del colore fare riferimento ai codici del campionario pelli.

### Caratteristiche optional su richiesta con maggiorazione

- Poggiatesta (Cod.9900) con imbottitura in poliuretano espanso e supporto in metallo rivestito.
- Per il multi rivestimento il prezzo va incrementato del 7%. Per maggiori dettagli fare riferimento al paragrafo "NOTE" posto nelle prime pagine del listino.

### Note

- (\*) Non è possibile realizzare il rivestimento con pelli di spessore maggiore di 1.8 mm, tra cui l'articolo Nobile.
- Gli elementi Cod.H4004 - H4051 - H4052 possono essere utilizzati indifferentemente con i gruppi A - B.
- L'elemento Cod.H8027 può essere utilizzato come modulo centrale indifferentemente con i gruppi A - B.
- Gli elementi Cod.H6021 - H6022 sono versioni singole che non possono essere agganciate ad un elemento componibile.
- I disegni grafici che riportano l'asterisco (\*) sono sempre con lato rifinito e anche agganciabili agli elementi componibili.

### Standard features

- Frame: wooden structure, seat suspensions in reinforced elastic webbing.
- Padding in eco-friendly open cell polyurethane foam, with different densities, covered with a mixed feather layer.
- Covering in leather or fabric. Not removable coverings.
- Legs in black thermoplastic material.
- (\*) Stitching type Cod.04 for leather and fabric coverings.
- Stitching type Cod.06 on the top part of the seat and the back part of the armrest only for leather covering.
- No bed version available.
- Sectional sides finished.
- Versions with removable fabric covering are equipped with bayonet connectors for armrests only.

### Optional features without any upcharge

- Contrast stitching available. Please refer to our leather collection for a thread color indication.

### Optional features with upcharge

- Headrest (Cod.9900) with padding in open cell polyurethane foam and covered metal structure.
- 7% upcharge for combined coverings. Please refer to the notes at the beginning of pricelist.

### Notes

- (\*) Covering not available with leathers thicker than 1.8 mm, such as leather Nobile.
- Versions Cod.H4004 - H4051 - H4052 can be used with groups A - B.
- Version Cod.H8027 can be used as a central piece with groups A - B.
- Versions Cod.H6021 - H6022 are free-standing and cannot be attached to modular elements.
- Versions with asterisk (\*) have always the finished terminal side with the possibility to be connected to modular elements.

Cuciture//  
Stitching

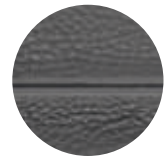

Cod.04

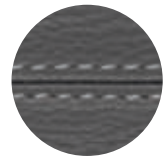

Cod.06

Poggiatesta//  
Headrest



### Versioni \ Versions

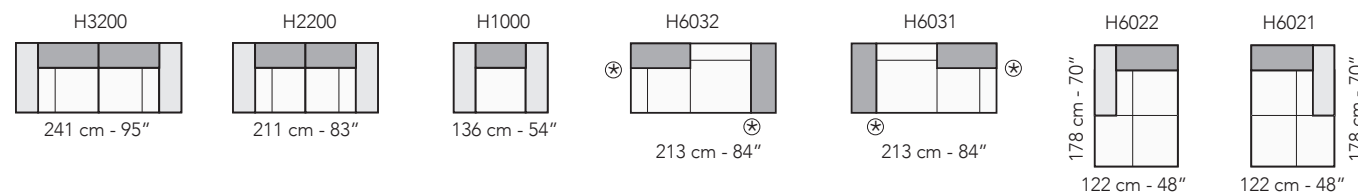

### Versioni \ Versions

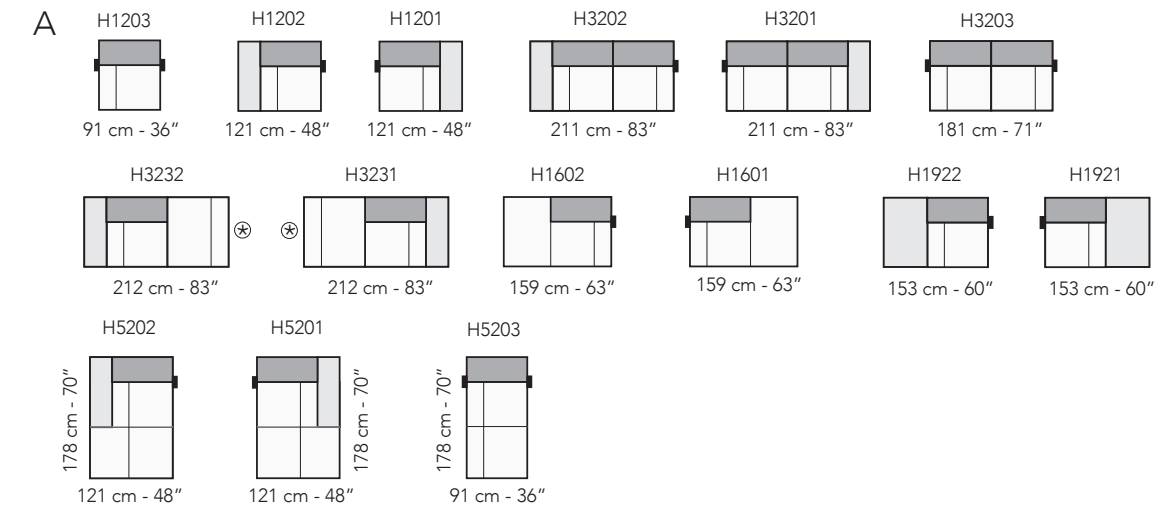

tutti gli elementi del gruppo A hanno lo stesso modulo di seduta - all items in group A have the same seat width

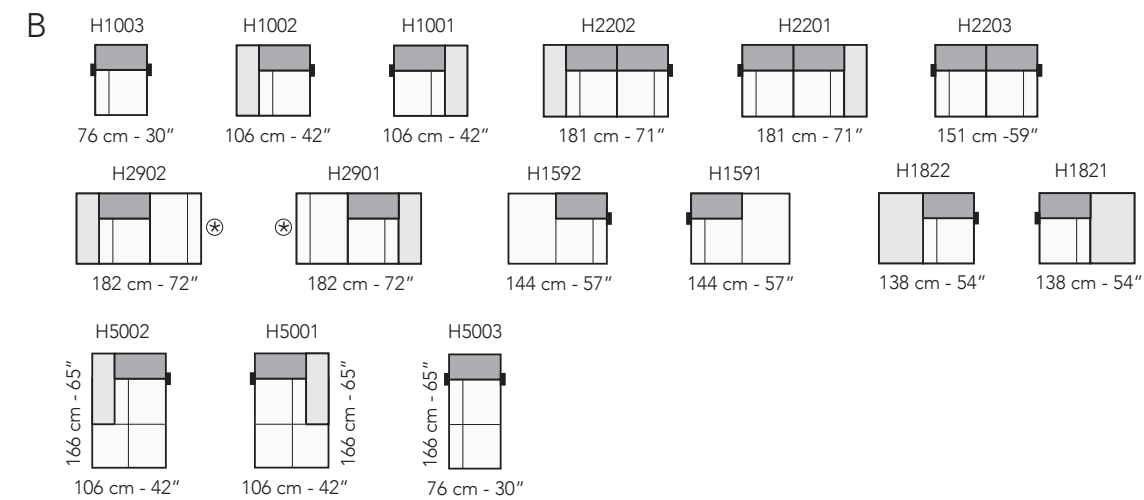

tutti gli elementi del gruppo B hanno lo stesso modulo di seduta - all items in group B have the same seat width

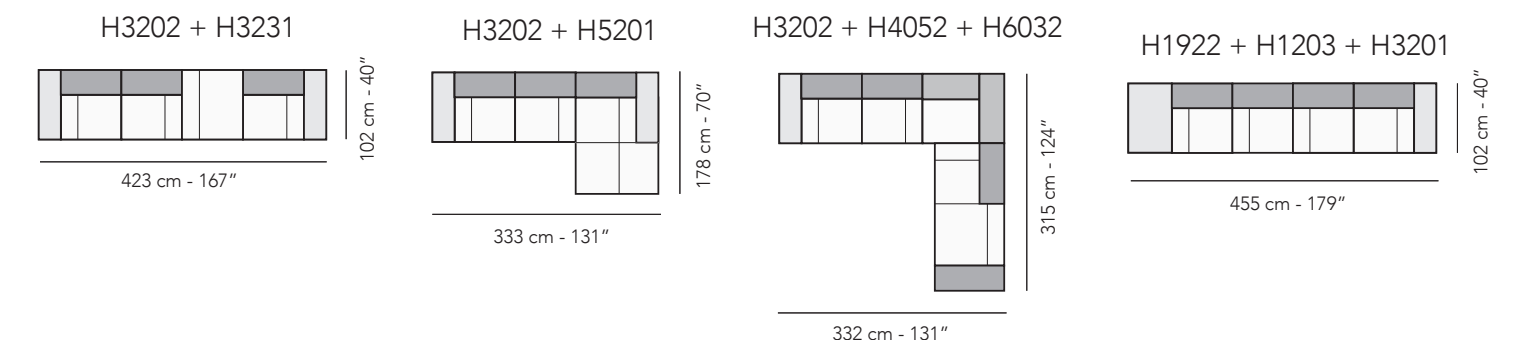
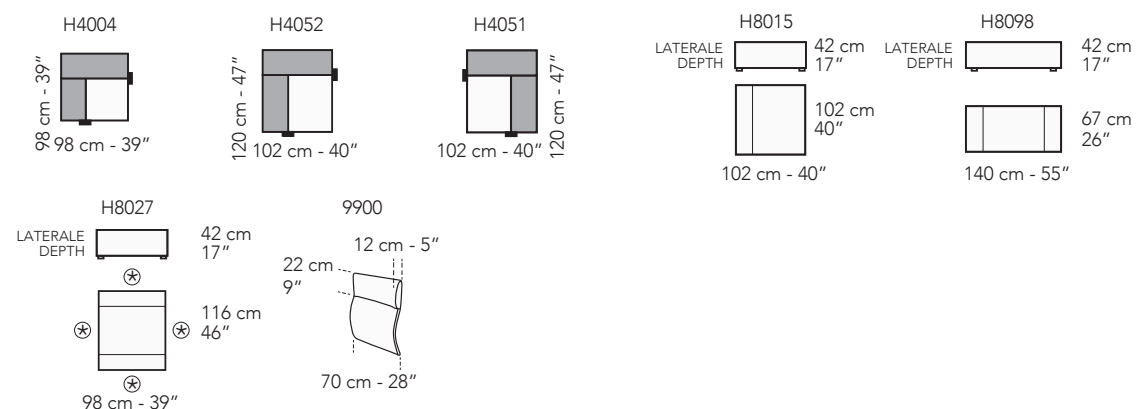

Composizioni consigliate - Recommended compositions

### Legenda - Legend

- Spalliera / Back Cushions
- Poggiaresi / Kidneyrest
- Bracciolo / Armrest
- Marmo / Marble
- Legno / Wood
- Aggancio Componibile / Connector

- Seduta / Seat Cushions
- Sistema Sound

\* Lato terminale sempre rifinito e agganciabile agli elementi componibili / Terminal side is always finished and it can also be connected to modular elements



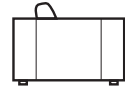

# Cairolì High Deep



frontale - front      laterale - depth      laterale br big - big arm depth

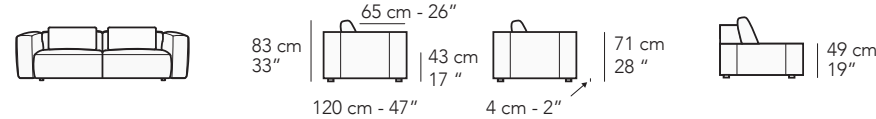

## Caratteristiche standard

- Struttura in legno e multistrato, molleggio seduta con cinghie elastiche.
- Imbottitura in poliuretano espanso ecologico a cellula aperta con densità differenziate, rivestito da un materassino in misto piuma.
- Cuscino di spalliera removibile in misto piuma.
- Rivestimento in pelle o tessuto. Tutti i rivestimenti sono fissi, con cuscino di spalliera sfoderabile.
- Solo per il mercato ITALIA il rivestimento in tessuto è completamente sfoderabile.
- Piedi in materiale termoplastico nero.
- (\*) Cucitura Cod.04 per rivestimento in pelle e tessuto.
- Cucitura Cod.06 sulla parte superiore della seduta e parte posteriore bracciolo solo per rivestimento in pelle.
- Inserimento letto non possibile.
- Lato componibile rifinito.
- Per tutte le versioni in tessuto sfoderabile i braccioli solo removibili con sistema a baionetta.

## Caratteristiche optional su richiesta senza maggiorazione

- Disponibile con cucitura a contrasto, per la scelta del colore fare riferimento ai codici del campionario pelli.

## Caratteristiche optional su richiesta con maggiorazione

- Per il multi rivestimento il prezzo va incrementato del 7%. Per maggiori dettagli fare riferimento al paragrafo "NOTE" posto nelle prime pagine del listino.

## Note

- (\*) Non è possibile realizzare il rivestimento con pelli di spessore maggiore di 1.8 mm, tra cui l'articolo Nobile.
- Gli elementi Cod.HD4004 - HD4051 - HD4052 possono essere utilizzati indifferente con i gruppi A - B.
- L'elemento Cod.HD8027 può essere utilizzato come modulo centrale indifferente con i gruppi A - B.
- Gli elementi Cod.HD6021 - HD6022 sono versioni singole che non possono essere agganciate ad un elemento componibile.
- I disegni grafici che riportano l'asterisco (\*) sono sempre con lato rifinito e anche agganciabili agli elementi componibili.

## Standard features

- Frame: wooden structure, seat suspensions in reinforced elastic webbing.
- Padding in eco-friendly open cell polyurethane foam, with different densities, covered with a mixed feather layer.
- Back cushions with padding in mixed feather. Cushions are removable.
- Covering in leather or fabric. Not removable coverings except for back cushions coverings.
- Legs in black thermoplastic material.
- (\*) Stitching type Cod.04 for leather and fabric coverings.
- Stitching type Cod.06 on the top part of the seat and the back part of the armrest only for leather covering.
- No bed version available.
- Sectional sides finished.
- Versions with removable fabric covering are equipped with bayonet connectors for armrests only.

## Optional features without any upcharge

- Contrast stitching available. Please refer to our leather collection for a thread color indication.

## Optional features with upcharge

- 7% upcharge for combined coverings. Please refer to the notes at the beginning of pricelist.

## Notes

- (\*) Covering not available with leathers thicker than 1.8 mm, such as leather Nobile.
- Versions Cod.HD4004 - HD4051 - HD4052 can be used with groups A - B.
- Version Cod.HD8027 can be used as a central piece with groups A - B.
- Versions Cod.HD6021 - HD6022 are free-standing and cannot be attached to modular elements.
- Versions with asterisk (\*) have always the finished terminal side with the possibility to be connected to modular elements.

Cuciture//  
Stitching

Tessuto  
Fabric  
Pelle  
Leather

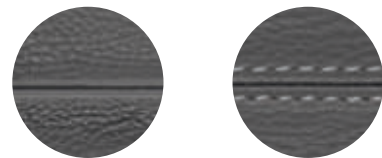

Cod.04

Cod.06

## Modularità

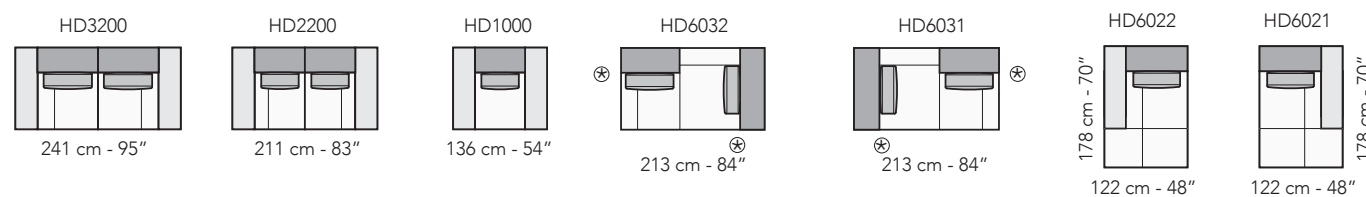

## Versioni \ Versions

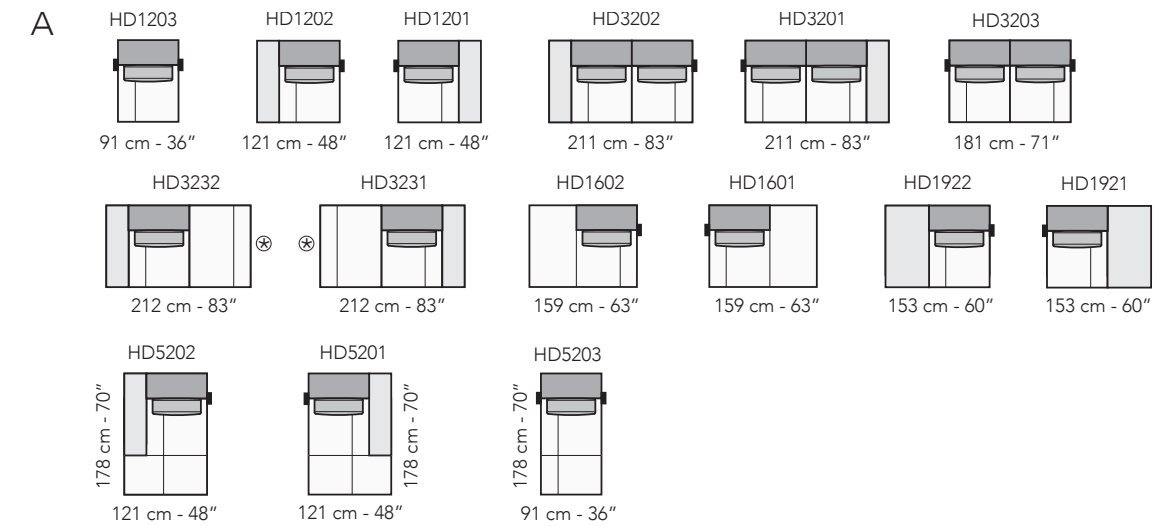

tutti gli elementi del gruppo A hanno lo stesso modulo di seduta - all items in group A have the same seat width

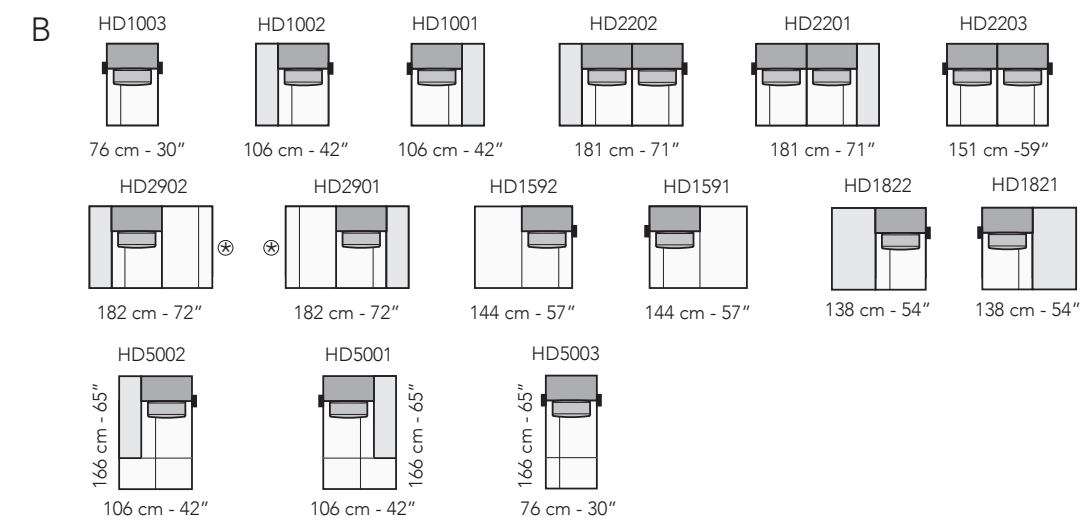

tutti gli elementi del gruppo B hanno lo stesso modulo di seduta - all items in group B have the same seat width

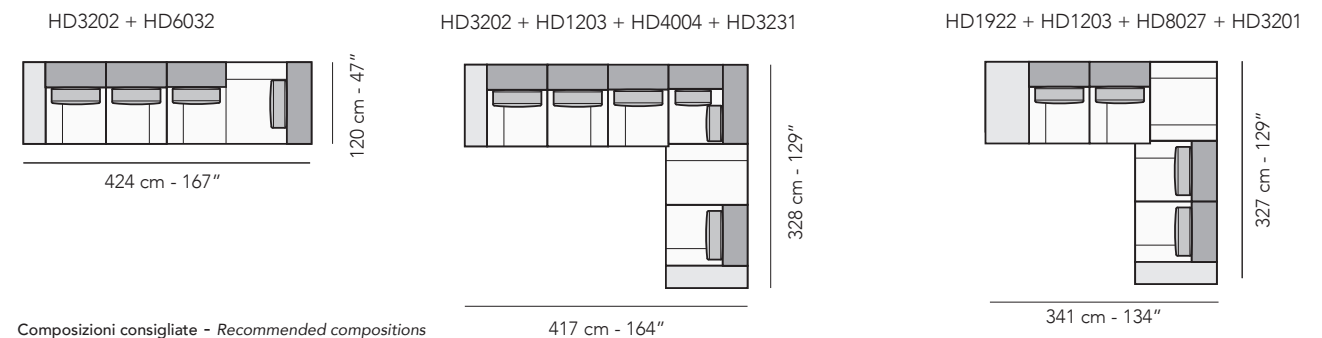
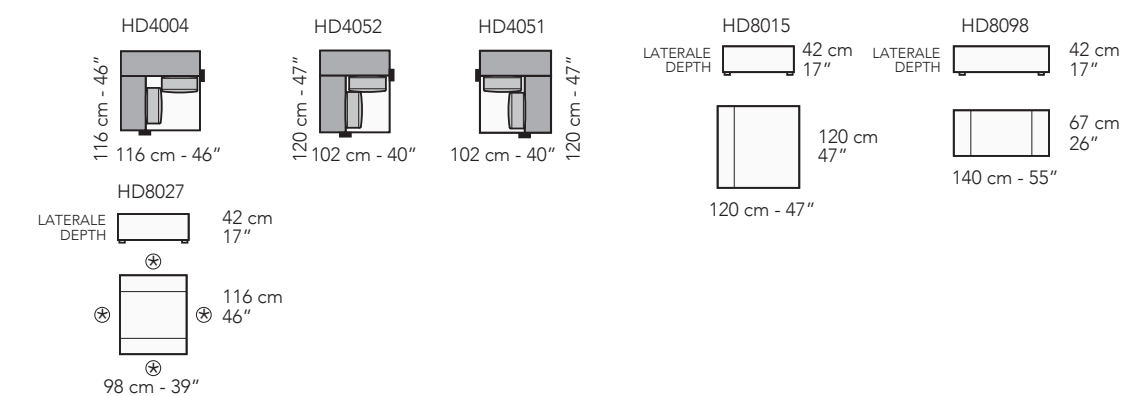

Composizioni consigliate - Recommended compositions

## Legenda - Legend

- Spalliera / Back Cushions
- Poggiatesta / Kidneyrest
- Bracciolo / Armrest
- Marmo / Marble
- Legno / Wood
- Aggancio Componibile / Connector

- Seduta / Seat Cushions
- Sistema Sound

\* Lato terminale sempre rifinito e agganciabile agli elementi componibili / Terminal side is always finished and it can also be connected to modular elements



# Cordusio

design application N° 402019000000467



frontale - front

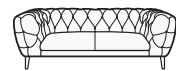

laterale - depth

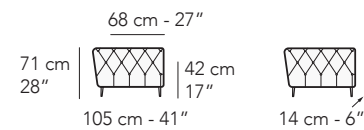

## Caratteristiche standard

- Struttura in legno e multistrato, molleggio seduta con cinghie elastiche.
- Imbottitura in poliuretano espanso ecologico a cellula aperta con densità differenziate, rivestito con falda di Tecnoform.
- Rivestimento in pelle o tessuto.
- Cuscini di seduta sfoderabili per tutti i rivestimenti.
- Piede in metallo Lucido (Cod.30), Satinato (Cod.31), Canna di fucile (Cod.50).
- Cucitura Cod.03 per cuscino di seduta.
- Cucitura Cod.06 per parte superiore della seduta con rivestimento in pelle.
- Inserimento letto non possibile.

## Caratteristiche optional su richiesta senza maggiorazione

- Disponibile con cucitura a contrasto, per la scelta del colore fare riferimento ai codici del campionario pelli.

## Caratteristiche optional su richiesta con maggiorazione

- Disponibile set cuscinetti lombari con rivestimento sfoderabile e imbottitura in poliuretano espanso.
- Per il multi rivestimento il prezzo va incrementato del 7%. Per maggiori dettagli fare riferimento al paragrafo "NOTE" posto nelle prime pagine del listino.

## Note

- Non è possibile realizzare il rivestimento con l'articolo Nabuk Hi-Tech e con pelli di spessore maggiore di 1.8 mm, tra cui l'articolo Nobile.

## Standard features

- *Frame: wooden structure, seat suspensions in reinforced elastic webbing.*
- *Padding in eco-friendly open cell polyurethane foam, with different densities, covered with a mixed feather layer.*
- *Covering in leather or fabric. Not removable coverings except for seat cushions.*
- *Legs in Shiny metal (Cod.30), Satin (Cod.31), Gunmetal (Cod.50).*
- *Stitching type Cod.03 for seat cushion.*
- *Stitching type Cod.06 on the top part of the seat for leather coverings.*
- *No bed version available.*

## Optional features without any upcharge

- *Contrast stitching available. Please refer to our leather collection for a thread color indication.*

## Optional features with upcharge

- *Set of lumbar cushions available. Removable covering and padding in eco-friendly open cell polyurethane foam.*
- *7% upcharge for combined coverings. Please refer to the notes at the beginning of pricelist.*

## Notes

- *Covering not available with Nabuk Hi-Tech item and with leather thicker than 1.8 mm, such as leather Nobile.*

Cuciture//  
Stitching

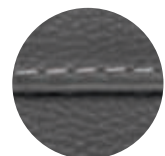

Cod.03

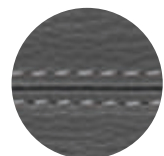

Cod.06

Tessuto  
Fabric  
Pelle  
Leather

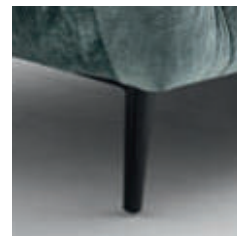

Piede in metallo //  
Metal Legs



Shiny Metal



Satin Metal



Gunmetal

## Versioni \ Versions

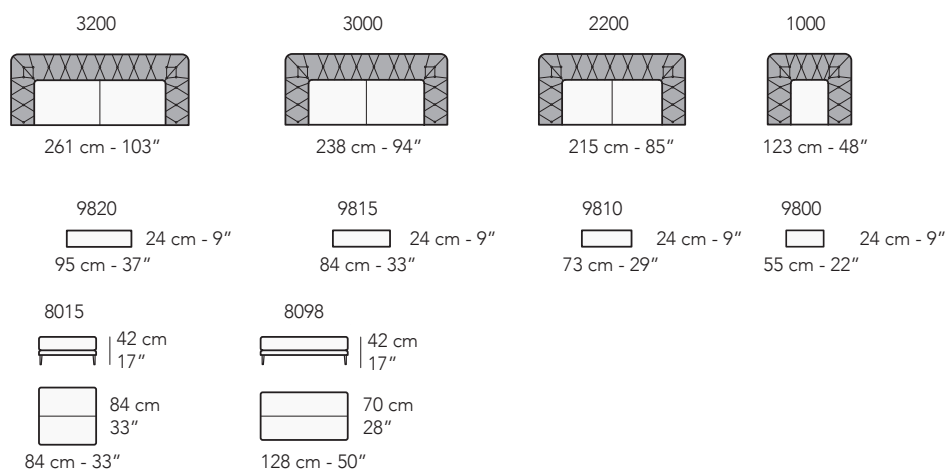

## Legenda - Legend

- Spalliera / Back Cushions
- Poggiareni / Kidneyrest
- Bracciolo / Armrest
- Marmo / Marble
- Legno / Wood
- Aggancio Componibile / Connector
- Seduta / Seat Cushions
- Sistema Sound

\* Lato terminale sempre rifinito e agganciabile agli elementi componibili / Terminal side is always finished and it can also be connected to modular elements

# Duomo

design application N° 402019000000467



frontale - front

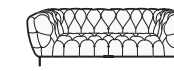

laterale - depth

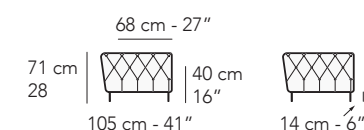

## Caratteristiche standard

- Struttura in legno e multistrato, molleggio seduta con cinghie elastiche.
- Imbottitura in poliuretano espanso ecologico a cellula aperta con densità differenziate, rivestito con falda di Tecnoform.
- Rivestimento in pelle o tessuto. Tutti i rivestimenti sono fissi.
- Piede in metallo Lucido (Cod.30), Satinato (Cod.31), Canna di fucile (Cod.50).
- Inserimento letto non possibile.

## Caratteristiche optional su richiesta senza maggiorazione

- Disponibile con cucitura a contrasto, per la scelta del colore fare riferimento ai codici del campionario pelli.

## Caratteristiche optional su richiesta con maggiorazione

- Disponibile set cuscinetti lombari con rivestimento sfoderabile e imbottitura in poliuretano espanso.
- Per il multi rivestimento il prezzo va incrementato del 7%. Per maggiori dettagli fare riferimento al paragrafo "NOTE" posto nelle prime pagine del listino.

## Note

- Non è possibile realizzare il rivestimento con l'articolo Nabuk Hi-Tech e con pelli di spessore maggiore di 1.8 mm, tra cui l'articolo Nobile.

## Standard features

- *Frame: wooden structure, seat suspensions in reinforced elastic webbing.*
- *Padding in eco-friendly open cell polyurethane foam, with different densities, covered with a Tecnoform layer.*
- *Covering in leather or fabric. Not removable coverings.*
- *Legs in Shiny metal (Cod.30), Satin (Cod.31), Gunmetal (Cod.50).*
- *No bed version available.*

## Optional features without any upcharge

- *Contrast stitching available. Please refer to our leather collection for a thread color indication.*

## Optional features with upcharge

- *Set of lumbar cushions available. Removable covering and padding in eco-friendly open cell polyurethane foam.*
- *7% upcharge for combined coverings. Please refer to the notes at the beginning of pricelist.*

## Notes

- *Covering not available with Nabuk Hi-Tech item and with leather thicker than 1.8 mm, such as leather Nobile.*



Piede in metallo //  
Metal Legs



Shiny Metal



Satin Metal



Gunmetal

## Versioni \ Versions

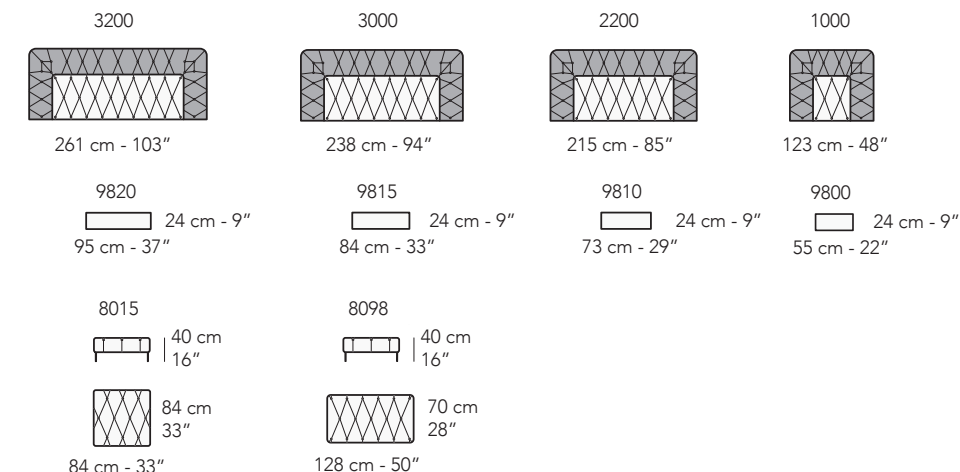

## Legenda - Legend

- Spalliera / Back Cushions
- Poggiareni / Kidneyrest
- Bracciolo / Armrest
- Marmo / Marble
- Legno / Wood
- Aggancio Componibile / Connector
- Seduta / Seat Cushions
- Sistema Sound

\* Lato terminale sempre rifinito e agganciabile agli elementi componibili / Terminal side is always finished and it can also be connected to modular elements



# Isola

Design application n° 402018000002313



frontale - front

laterale - depth

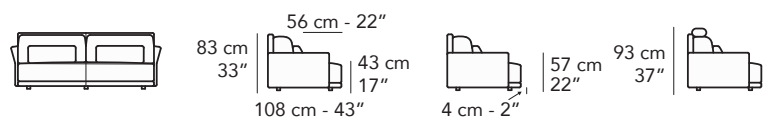

## Caratteristiche standard

- Struttura in legno e multistrato, molleggio seduta con cinghie elastiche.
- Cuscini di seduta in poliuretano espanso ecologico a cellula aperta rivestito da una falda di Tecnoform.
- Cuscini di spalliera in fibra "Extra soft" e inserto in poliuretano espanso ecologico a cellula aperta.
- Cuscinetto lombare in piuma.
- Rivestimento in pelle o tessuto.
- Per tutti i rivestimenti sono sfoderabili i cuscini di spalliera e quelli lombari.
- Piedi in materiale termoplastico nero.
- Elementi Cod.1341 - 1342 - 1361 - 1362 - 1771 - 1772 - 1781 - 1782 sono corredati da mobile contenitore in legno Noce canaletto (Cod.10), aperto sia sulla parte anteriore che sulla parte superiore (vedi Fig.1).
- Elementi Cod.1411 - 1412 - 1761 - 1762 sono corredati da mobile contenitore in legno Noce canaletto (Cod.10), aperto sia sulla parte anteriore che nella parte laterale (vedi Fig.2).
- Cucitura Cod.03 per rivestimento in pelle e tessuto.
- Inserimento letto non possibile.
- Lato componibile rifinito.

## Caratteristiche optional su richiesta senza maggiorazione

- Nessuna maggiorazione in caso di scelta dei soli schienali/cuscini lombari in pelle o tessuto.
- Disponibile con cucitura a contrasto, per la scelta del colore fare riferimento ai codici del campionario pelli.

## Caratteristiche optional su richiesta con maggiorazione

- Poggiatesta (Cod.9900) con imbottitura in poliuretano espanso e supporto in metallo rivestito.
- Per il multi rivestimento il prezzo va incrementato del 7%. Per maggiori dettagli fare riferimento al paragrafo "NOTE" posto nelle prime pagine del listino.

## Note

- Non è possibile applicare altre cuciture.
- Gli elementi Cod.8015 - 8098 possono essere utilizzati anche come elementi componibili e quindi inseriti all'interno di una composizione.
- Gli elementi Cod.4051 - 4052 possono essere utilizzati indifferentemente con i gruppi A - B.
- I disegni grafici che riportano l'asterisco (\*) sono sempre con lato rifinito e anche agganciabili agli elementi componibili.

Cuciture//  
Stitching

Tessuto  
Fabric  
Pelle  
Leather

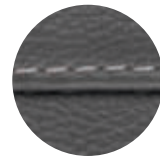

Cod.03

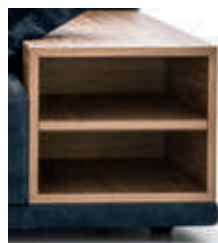

Contenitore in legno //  
wooden storage



Canaletto  
Walnut

## Versioni \ Versions

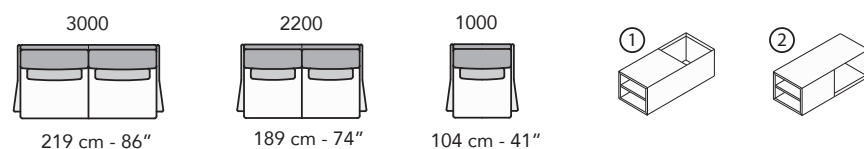

## Versioni \ Versions

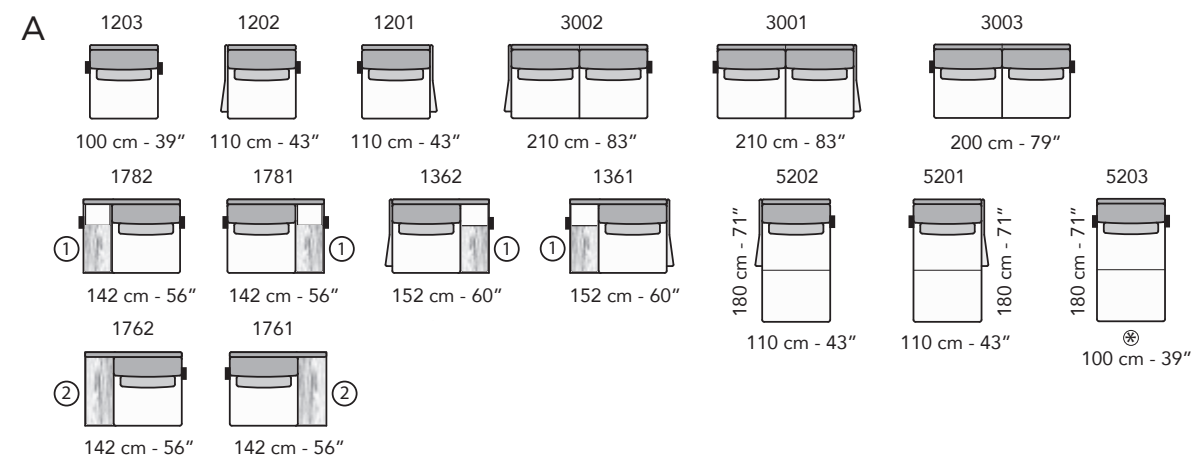

tutti gli elementi del gruppo A hanno lo stesso modulo di seduta - all items in group A have the same seat width

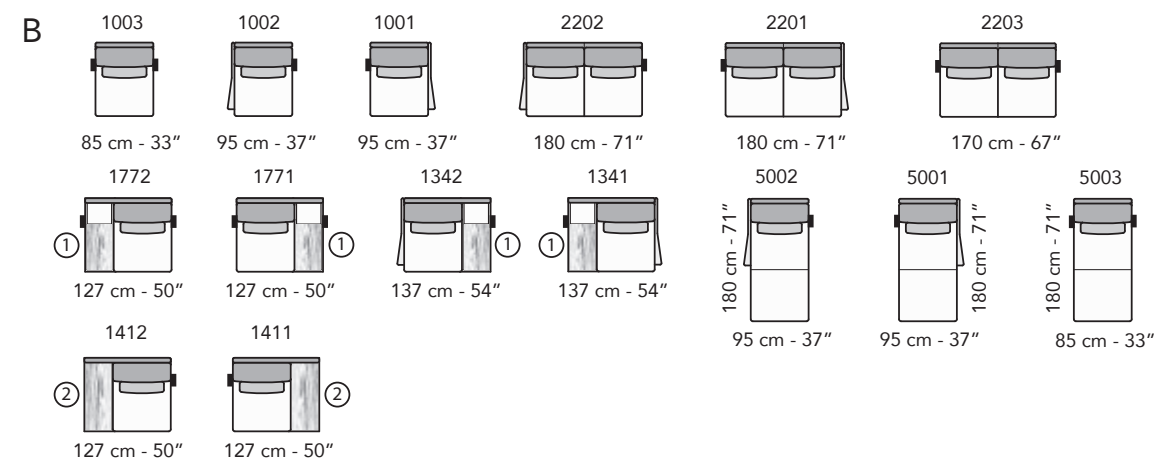

tutti gli elementi del gruppo B hanno lo stesso modulo di seduta - all items in group B have the same seat width

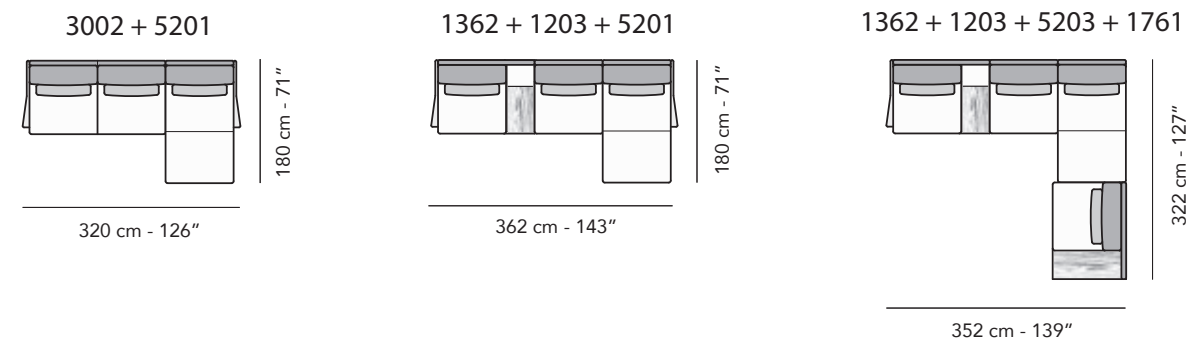
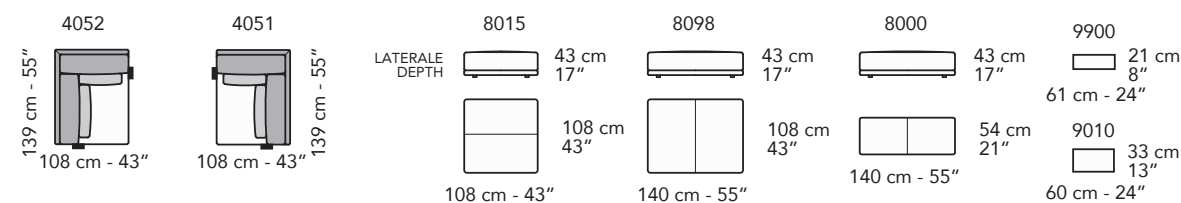

Composizioni consigliate - Recommended compositions

## Legenda - Legend

- Spalliera / Back Cushions
- Poggiareni / Kidneyrest
- Bracciolo / Armrest
- Marmo / Marble
- Legno / Wood
- Aggancio Componibile / Connector

- Seduta / Seat Cushions
- Sistema Sound

\* Lato terminale sempre rifinito e agganciabile agli elementi componibili / Terminal side is always finished and it can also be connected to modular elements



# Nausicaa

Design Application N°402016000053464



frontale - front



laterale - depth

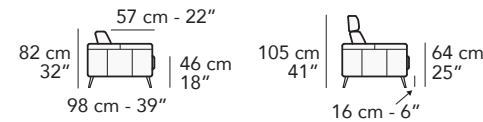

## Caratteristiche standard

- Struttura in legno e multistrato, molleggio seduta e spalliera con cinghie elastiche.
- Imbottitura in poliuretano espanso ecologico a cellula aperta con densità differenziate, rivestito da falda di Tecnoform.
- Rivestimento in pelle o tessuto con cuscini di seduta e spalliera sfoderabili.
- Solo per il mercato ITALIA il rivestimento in tessuto è completamente sfoderabile.
- Piede in metallo Lucido (Cod.30), Satinato (Cod.31), Canna di fucile (Cod.50).
- Elementi Cod.1431 - 1432 - 1491 - 1492 - 1681 - 1682 - 2041 - 2042 - 2251 - 2252 - 3041 - 3042 - 8090 con ripiano in legno Noce canaletto (Cod.10).
- Elementi Cod.1421 - 1422 - 1501 - 1502 - 1671 - 1672 - 2031 - 2032 - 2341 - 2342 - 3031 - 3032 - 8091 con ripiano in marmo Emperador (Cod.EM) oppure con marmo bianco Carrara (Cod.CA).
- Cucitura Cod.06 per rivestimento in pelle.
- Inserimento letto non possibile.
- Lato componibile rifinito.

## Caratteristiche optional su richiesta senza maggiorazione

- Disponibile con cucitura a contrasto, per la scelta del colore fare riferimento ai codici del campionario pelli.

## Caratteristiche optional su richiesta con maggiorazione

- Poggiatesta (Cod.9900) con imbottitura in poliuretano espanso ecologico a cellula aperta e rivestimento sfoderabile.
- Per il multi rivestimento il prezzo va incrementato del 3%. Per maggiori dettagli fare riferimento al paragrafo "NOTE" posto nelle prime pagine del listino.

## Note

- Non è possibile applicare altre cuciture.
- Gli elementi Cod.4014 - 4015 - 4404 - 8090 - 8091 possono essere utilizzati indifferenteemente con i gruppi A - B - C.
- I disegni grafici che riportano l'asterisco (\*) sono sempre con lato rifinito e anche aganciabili agli elementi componibili.



Piede in metallo // Metal Legs



Shiny Metal Satin Metal Gunmetal

Cuciture// Stitching

Tessuto Fabric Pelle Leather

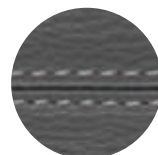

Cod.06

## Standard features

- *Frame: wooden structure, seat and back suspensions in reinforced elastic webbing.*
- *Seat cushions with padding in eco-friendly open cell polyurethane foam, with different densities, covered with a Tecnoform layer.*
- *Covering in leather or fabric. Seat and back cushions coverings removable.*
- *Legs in Shiny metal (Cod.30), Satin (Cod.31), Gunmetal (Cod.50).*
- *Versions Cod.1431 - 1432 - 1491 - 1492 - 1681 - 1682 - 2041 - 2042 - 2251 - 2252 - 3041 - 3042 - 8090 with wooden top in Canaletto walnut (Cod.10).*
- *Versions Cod.1421 - 1422 - 1501 - 1502 - 1671 - 1672 - 2031 - 2032 - 2341 - 2342 - 3031 - 3032 - 8091 with top in marble Emperador (Cod.EM) or Carrara white marble (Cod. CA).*
- *Stitching type Cod.06 for leather covering.*
- *No bed version available.*
- *Sectional sides finished.*

## Optional features without any upcharge

- *Contrast stitching available. Please refer to our leather collection for a thread color indication.*

## Optional features with upcharge

- *Headrest (Cod.9900) with padding in open cell polyurethane foam and removable covering.*
- *3% upcharge for combined coverings. Please refer to the notes at the beginning of pricelist.*

## Notes

- *Different stitchings not available.*
- *Version Cod.4014 - 4015 - 4004 - 8090 - 8091 can be used with groups A - B - C.*
- *Versions with asterisk (\*) have always the finished terminal side with the possibility to be connected to modular elements.*

## Versioni \ Versions

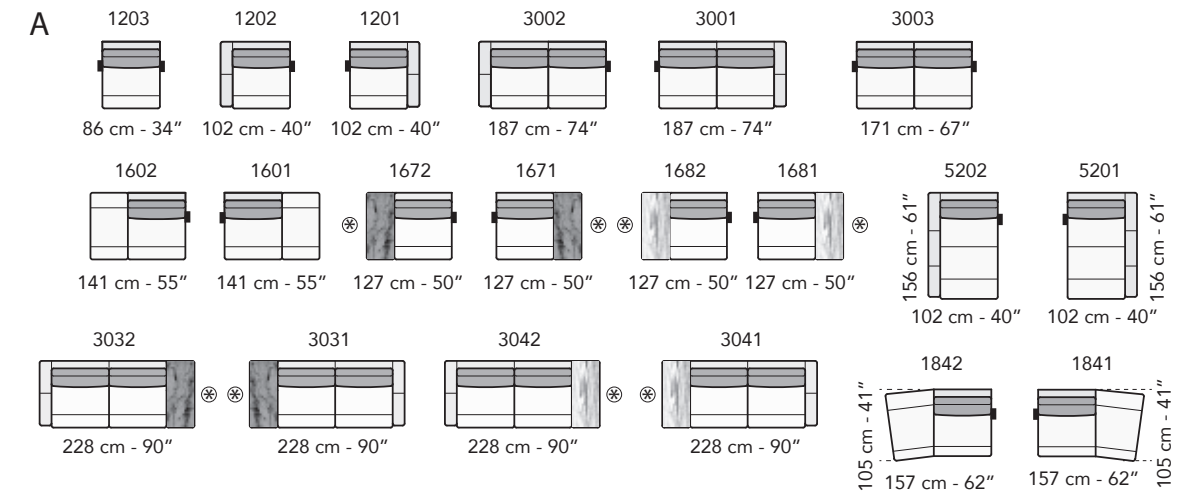
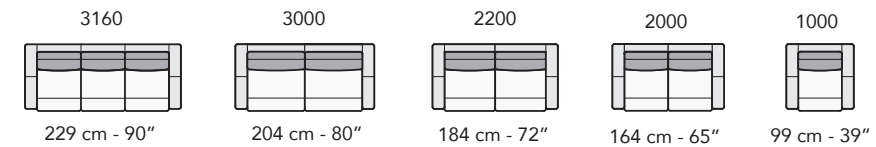

tutti gli elementi del gruppo A hanno lo stesso modulo di seduta - all items in group A have the same seat width

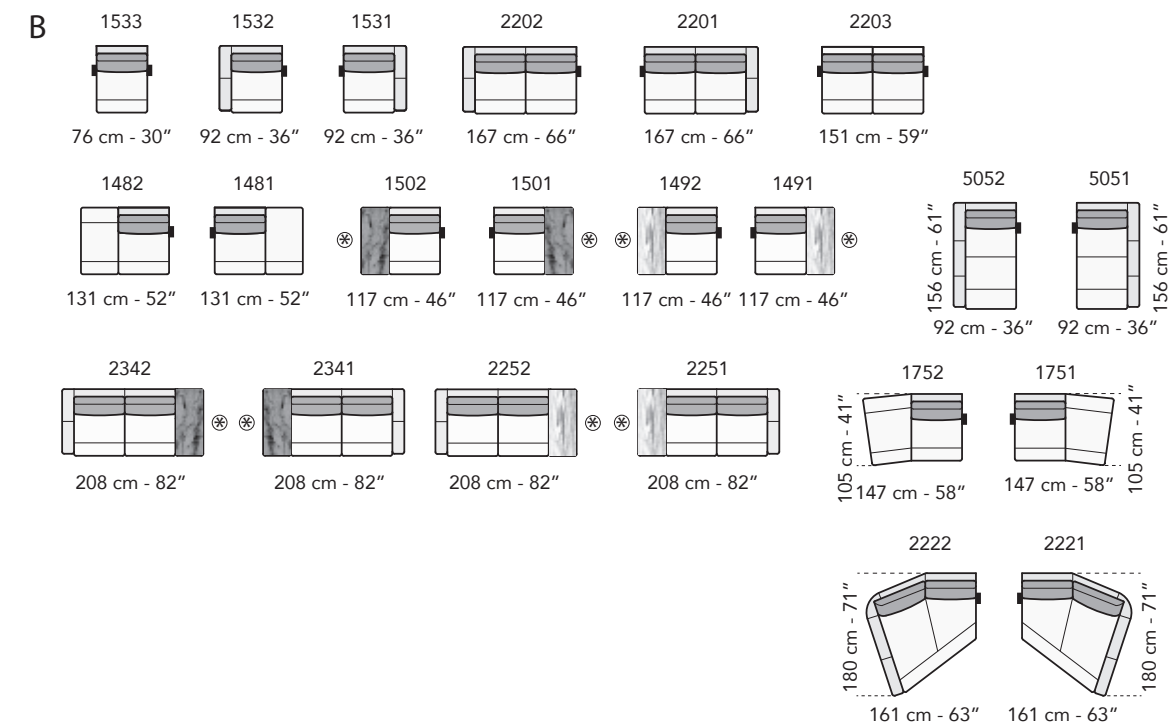

tutti gli elementi del gruppo B hanno lo stesso modulo di seduta - all items in group B have the same seat width



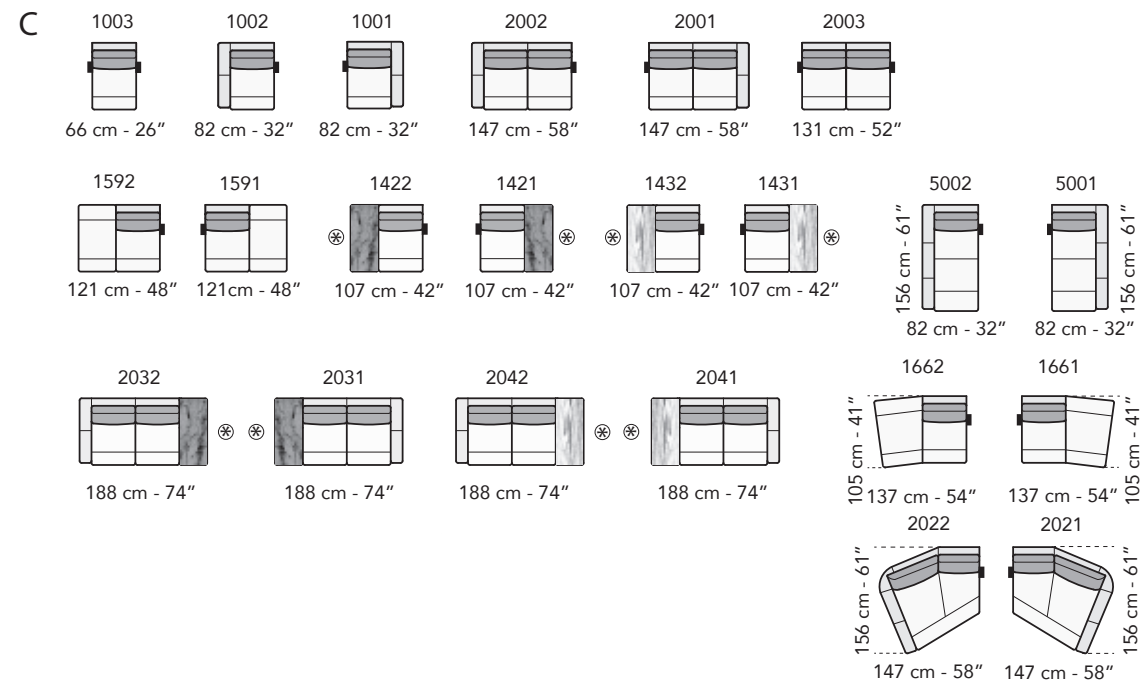

tutti gli elementi del gruppo C hanno lo stesso modulo di seduta - all items in group C have the same seat width

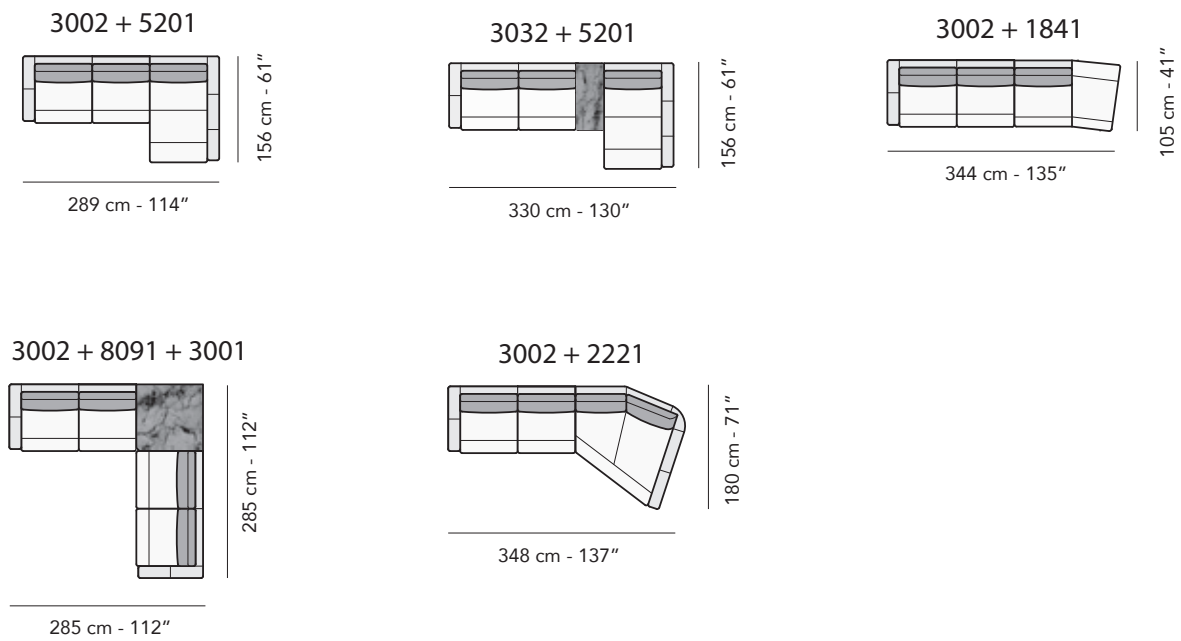
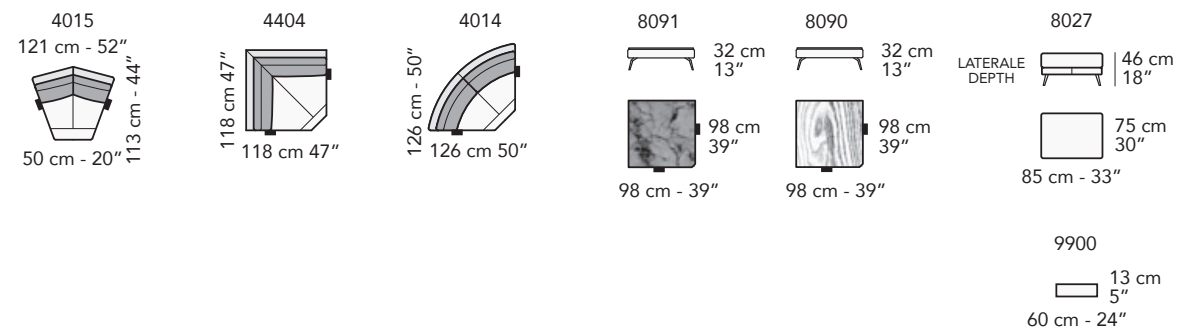

Composizioni consigliate - Recommended compositions

Legenda - Legend

- Spalliera / Back Cushions
- Poggiareni / Kidneyrest
- Bracciolo / Armrest
- Marmo / Marble
- Legno / Wood
- Aggancio Componibile / Connector
- Seduta / Seat Cushions
- Sistema Sound
- \* Lato terminale sempre rifinito e agganciabile agli elementi componibili / Terminal side is always finished and it can also be connected to modular elements



# Tortona \ living - small -leg

Design Application N° 402017000039849 - N° 402017000135505 - N° 402017000135505



frontale - front



laterale - depth

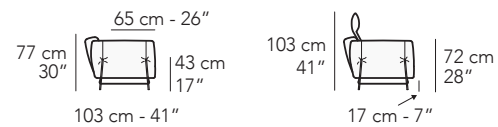

## Caratteristiche standard

- Struttura in legno e multistrato, molleggio seduta e spalliera con cinghie elastiche.
- Cuscini bracciolo in poliuretano espanso ecologico a cellula aperta rivestito da falda di Tecnoform.
- Cuscini di seduta in poliuretano espanso ecologico a cellula aperta con densità differenziate.
- Cuscini di spalliera in poliuretano espanso ecologico a cellula aperta rivestito da un materassino in misto piuma.
- Rivestimento in pelle o tessuto. Tutti i rivestimenti sono fissi.
- Piede in metallo Canna di fucile (Cod.50) con parte inferiore verniciata in colore oro satinato.
- Cucitura Cod.03 per rivestimento in pelle e tessuto.
- Inserimento letto non possibile.
- Lato componibile rifinito.

## Caratteristiche optional su richiesta senza maggiorazione

- Disponibile con cucitura a contrasto, per la scelta del colore fare riferimento ai codici del campionario pelli.

## Caratteristiche optional su richiesta con maggiorazione

- Tavolino terminale (Cod.9503) con struttura in metallo Canna di fucile (Cod.50) e ripiano in legno Noce canaletto (Cod.10), marmo Emperador (Cod.EM) oppure marmo bianco Carrara (Cod.CA), disponibile per le versioni Cod.1591 - 1592 - 1601 - 1602 - 1691 - 1692 - 1701 - 1702 - 2901 - 2902 - 3021 - 3022.
- Poggiatesta (Cod.9900) con imbottitura in poliuretano espanso e supporto in metallo rivestito.
- Per il multi rivestimento il prezzo va incrementato del 7%. Per maggiori dettagli fare riferimento al paragrafo "NOTE" posto nelle prime pagine del listino.

## Note

- Non è possibile applicare altre cuciture.
- L'elemento Cod.4404 può essere utilizzato indifferentemente con i gruppi A - B.

## Standard features

- *Frame: wooden structure, seat and back suspensions in reinforced elastic webbing.*
- *Armrest cushions with padding in eco-friendly open cell polyurethane foam, with different densities, covered with a Tecnoform layer.*
- *Seat cushions with padding in eco-friendly open cell polyurethane foam, with different densities.*
- *Back cushions with padding in eco-friendly open cell polyurethane foam, covered with a mixed feather layer.*
- *Covering in leather or fabric. Not removable coverings.*
- *Legs in Gunmetal (Cod.50) with lower part painted in matte gold color.*
- *Stitching type Cod.03 for leather and fabric coverings.*
- *No bed version available.*
- *Sectional sides finished.*

## Optional features without any upcharge

- *Contrast stitching available. Please refer to our leather collection for a thread color indication.*

## Optional features with upcharge

- *Terminal table (Cod.9503) with metal structure in Gunmetal (Cod.50) color and top in wood Canaletto walnut (Cod.10), Emperador marble (Cod.EM) or Carrara white marble (Cod.CA) attached to the structure available for the versions Cod.1591 - 1592 - 1601 - 1602 - 1691 - 1692 - 1701 - 1702 - 2901 - 2902 - 3021 - 3022.*
- *Headrest (Cod.9900) with padding in eco-friendly open cell polyurethane foam and covered metal support.*
- *7% upcharge for combined coverings. Please refer to the notes at the beginning of pricelist.*

## Notes

- *Different stitchings not available.*
- *Version Cod.4404 can be used with groups A - B.*



Piedino Living // Leg "Living"



Piedino Small // Leg "Small"



Piedino Leg // Leg "Leg"



Gunmetal and Matte gold color

Cuciture // Stitching

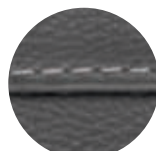

Cod.03

Tessuto // Fabric  
Pelle // Leather

Poggiatesta // Headrest



## Versioni \ Versions

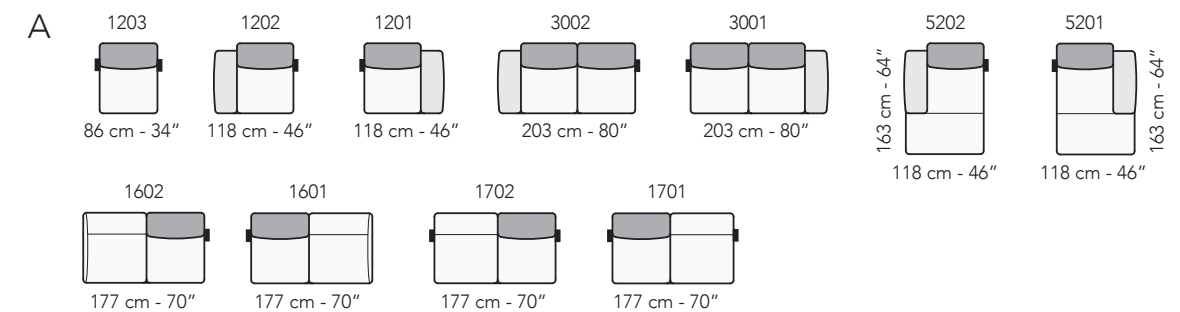
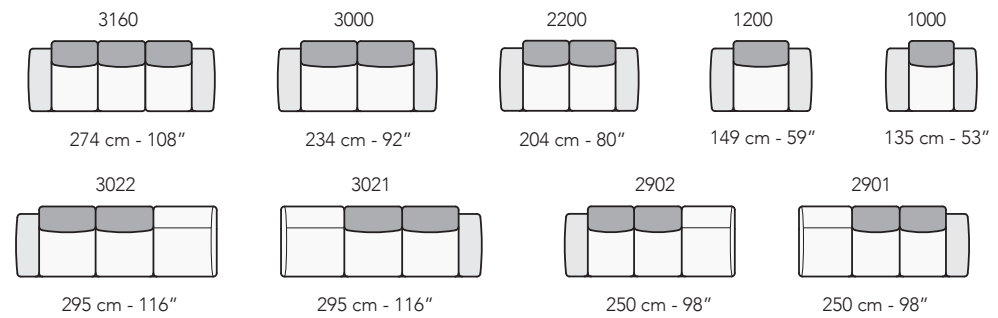

tutti gli elementi del gruppo A hanno lo stesso modulo di seduta - all items in group A have the same seat width

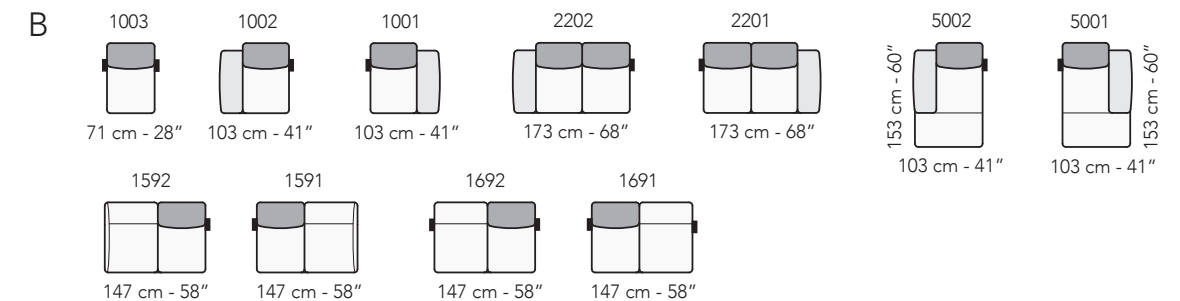

tutti gli elementi del gruppo B hanno lo stesso modulo di seduta - all items in group B have the same seat width

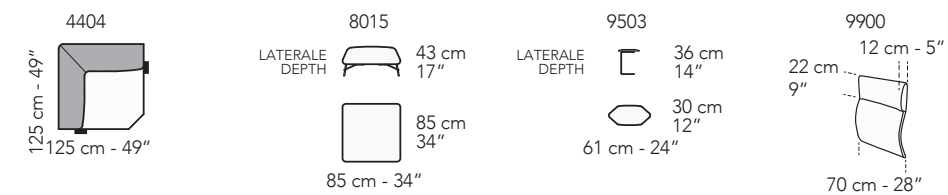

3002 + 4404 + 1601

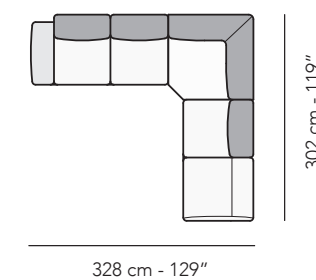

3002 + 4404 + 3001

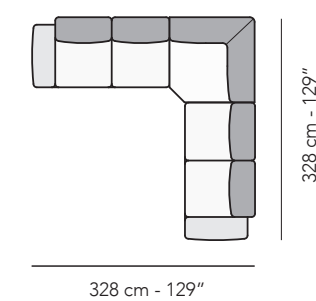

3002 + 5201

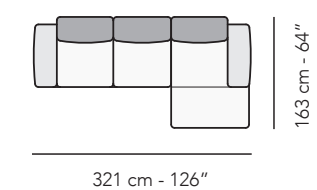

Composizioni consigliate - Recommended compositions

## Legenda - Legend

- Spalliera / Back Cushions
- Poggiaresi / Kidneyrest
- Bracciolo / Armrest
- Marmo / Marble
- Legno / Wood
- Aggancio Componibile / Connector

- Seduta / Seat Cushions
- Sistema Sound

\* Lato terminale sempre rifinito e agganciabile agli elementi componibili / Terminal side is always finished and it can also be connected to modular elements



# Turro\ living - small -leg

Design Application N° 402017000039849 - N° 402017000135505 - N° 402017000135505



frontale - front

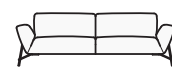

laterale - depth

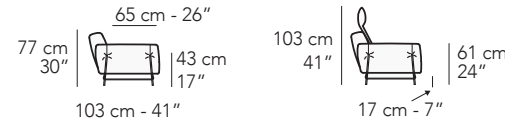

## Caratteristiche standard

- Struttura in legno e multistrato, molleggio seduta e spalliera con cinghie elastiche.
- Cuscini bracciolo in poliuretano espanso ecologico a cellula aperta rivestito da falda di Tecnoform.
- Cuscini di seduta in poliuretano espanso ecologico a cellula aperta con densità differenziate.
- Cuscini di spalliera in poliuretano espanso ecologico a cellula aperta rivestito da un materassino in misto piuma.
- Rivestimento in pelle o tessuto. Tutti i rivestimenti sono fissi.
- Piede in metallo Canna di fucile (Cod.50) con parte inferiore verniciata in colore oro satinato.
- Cucitura Cod.03 per rivestimento in pelle e tessuto.
- Inserimento letto non possibile.
- Lato componibile rifinito.

## Caratteristiche optional su richiesta senza maggiorazione

- Disponibile con cucitura a contrasto, per la scelta del colore fare riferimento ai codici del campionario pelli.

## Caratteristiche optional su richiesta con maggiorazione

- Tavolino terminale (Cod.9503) con struttura in metallo Canna di fucile (Cod.50) e ripiano in legno Noce canaletto (Cod.10), marmo Emperador (Cod.EM) oppure marmo bianco Carrara (Cod.CA), disponibile per le versioni Cod.1591 - 1592 - 1601 - 1602 - 1691 - 1692 - 1701 - 1702 - 2901 - 2902 - 3021 - 3022.
- Poggiatesta (Cod.9900) con imbottitura in poliuretano espanso e supporto in metallo rivestito.
- Per il multi rivestimento il prezzo va incrementato del 7%. Per maggiori dettagli fare riferimento al paragrafo "NOTE" posto nelle prime pagine del listino.

## Note

- Non è possibile applicare altre cuciture.
- L'elemento Cod.4404 può essere utilizzato indifferentemente con i gruppi A - B.

## Standard features

- *Frame: wooden structure, seat and back suspensions in reinforced elastic webbing.*
- *Armrest cushions with padding in eco-friendly open cell polyurethane foam, with different densities, covered with a Tecnoform layer.*
- *Seat cushions with padding in eco-friendly open cell polyurethane foam, with different densities.*
- *Back cushions with padding in eco-friendly open cell polyurethane foam, covered with a mixed feather layer.*
- *Covering in leather or fabric. Not removable coverings.*
- *Legs in Gunmetal (Cod.50) with lower part painted in matte gold color.*
- *Stitching type Cod.03 for leather and fabric coverings.*
- *No bed version available.*
- *Sectional sides finished.*

## Optional features without any upcharge

- *Contrast stitching available. Please refer to our leather collection for a thread color indication.*

## Optional features with upcharge

- *Terminal table (Cod.9503) with metal structure in Gunmetal (Cod.50) color and top in wood Canaletto walnut (Cod.10), Emperador marble (Cod.EM) or Carrara white marble (Cod.CA) attached to the structure available for the versions Cod.1591 - 1592 - 1601 - 1602 - 1691 - 1692 - 1701 - 1702 - 2901 - 2902 - 3021 - 3022.*
- *Headrest (Cod.9900) with padding in eco-friendly open cell polyurethane foam and covered metal support.*
- *7% upcharge for combined coverings. Please refer to the notes at the beginning of pricelist.*

## Notes

- *Different stitchings not available.*
- *Version Cod.4004 can be used with groups A - B.*



Piedino Living // Leg "Living"



Piedino Small // Leg "Small"



Piedino Leg // Leg "Leg"



Gunmetal and Matte gold color

Cuciture// Stitching

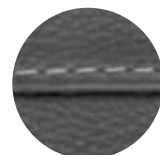

Cod.03

Tessuto  
Fabric  
Pelle  
Leather

Poggiatesta// Headrest



## Versioni \ Versions

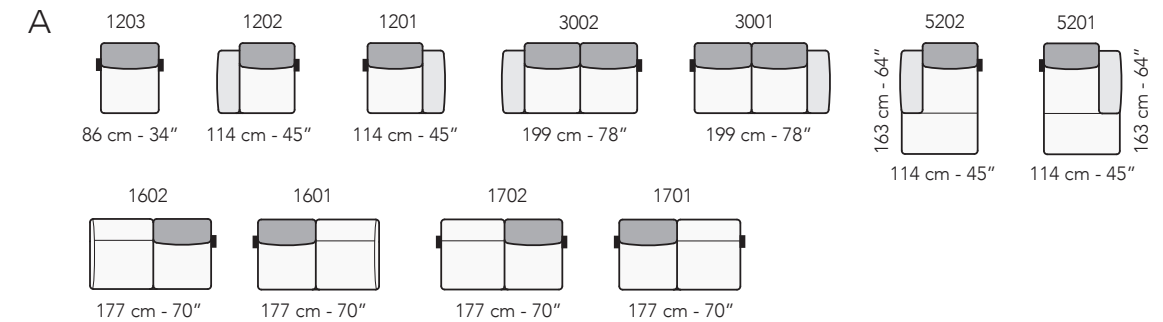
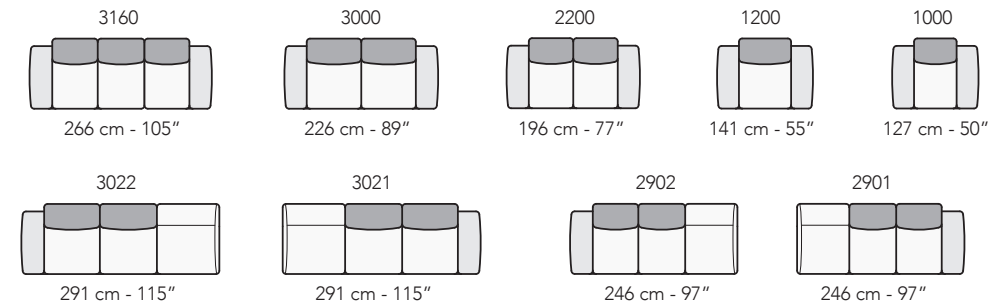

tutti gli elementi del gruppo A hanno lo stesso modulo di seduta - all items in group A have the same seat width

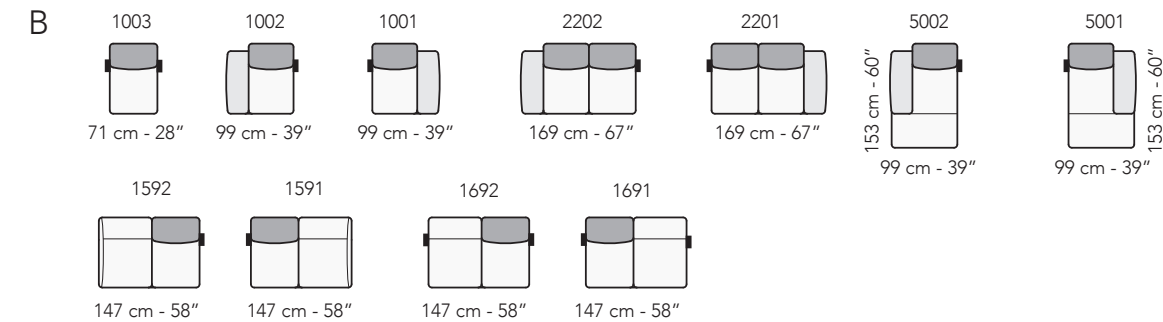

tutti gli elementi del gruppo B hanno lo stesso modulo di seduta - all items in group B have the same seat width

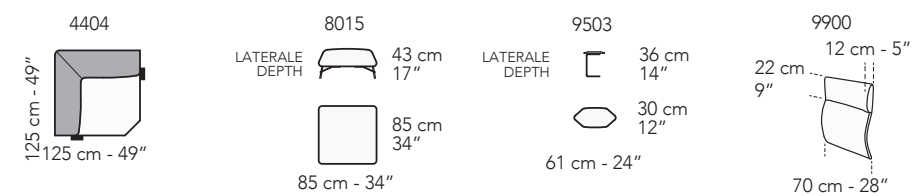

3002 + 4404 + 1601

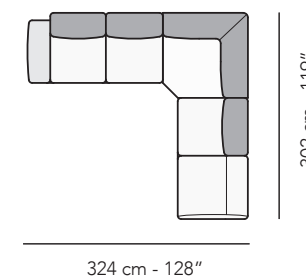

1202 + 1702 + 5201

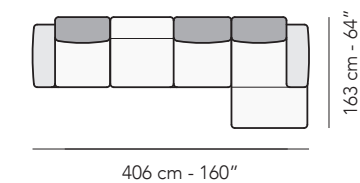

3002 + 5201

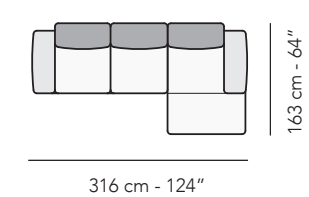

Composizioni consigliate - Recommended compositions

## Legenda - Legend

- Spalliera / Back Cushions
- Poggiaresi / Kidneyrest
- Bracciolo / Armrest
- Marmo / Marble
- Legno / Wood
- Aggancio Componibile / Connector

- Seduta / Seat Cushions
- Ⓢ Sistema Sound

\* Lato terminale sempre rifinito e agganciabile agli elementi componibili / Terminal side is always finished and it can also be connected to modular elements





# Zara

Design Application N° 40201800002313



frontale - front

laterale - depth

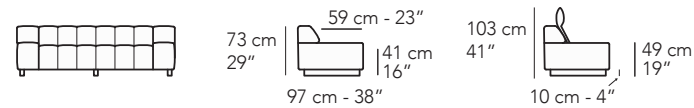

schede tecniche

### Caratteristiche standard

- Struttura in legno e multistrato, molleggio seduta e schienale con cinghie elastiche.
- Imbottitura in poliuretano espanso ecologico a cellula aperta con densità differenziate, rivestito da falda di Tecnoform.
- Rivestimento in pelle o tessuto. Tutti i rivestimenti sono fissi.
- Piedi in legno Laccato nero lucido (Cod.27).
- Il tavolino centrale Cod.9504 è disponibile con finitura Noce canaletto (Cod.10).
- Inserimento letto non possibile.
- Lato componibile rifinito.

### Caratteristiche optional su richiesta senza maggiorazione

- Disponibile con cucitura a contrasto. Per la scelta del colore fare riferimento ai codici del campionario pelli.

### Caratteristiche optional su richiesta con maggiorazione

- Poggiatesta (Cod.9900) con imbottitura in poliuretano espanso e supporto in metallo rivestito.
- Tavolino terminale (Cod.9503) con struttura in metallo Canna di fucile (Cod.50) e ripiano in marmo Emperador (Cod.EM) oppure con marmo bianco Carrara (Cod.CA) fissato alla struttura, per le versioni Cod.1091 - 1092 - 1701 - 1702 - 1841 - 1842 - 2901 - 2902 - 8001 - 8002.

### Note

- Solo per il rivestimento in pelle, sarà realizzato l'inserto in RIO (Fig.1). Per la scelta del colore fare riferimento alla cartellina COVERING HI-TECH.
- NON è possibile realizzare l'inserto in RIO per il rivestimento in tessuto. In tal caso sarà realizzata cucitura semplice (Fig.2).
- NON è possibile realizzare l'inserto in RIO per il rivestimento in pelle NOBILE e con spessori di pelle superiori a 1.8 mm. In tal caso sarà realizzata cucitura semplice (Fig. 3).
- Per tutte le pelli senza inserto RIO, sarà realizzata una cucitura semplice (Fig. 3).
- Non è possibile realizzare altre tipologie di rivestimento coordinato.

### Standard features

- Frame: wooden structure, seat and back suspensions in reinforced elastic webbing.
- Padding in eco-friendly open cell polyurethane foam, with different densities, covered with a Tecnoform layer.
- Covering in leather or fabric. Not removable coverings.
- Wooden legs in Black gloss lacquer (Cod.27).
- Central table Cod.9504 available with Canaletto walnut (Cod.10) finishing.
- No bed version available.
- Sectional sides finished.

### Optional features without any upcharge

- Contrast stitching available. Please refer to our leather collection for a thread color indication.

### Optional features with upcharge

- Headrest (Cod.9900) with padding in eco-friendly open cell polyurethane foam and covered metal support.
- Terminal table (Cod.9503) with metal structure in Gunmetal (Cod.50) color and top in Emperador marble (Cod.EM) or Carrara white marble (Cod.CA) attached to the structure available for the versions Cod.1091 - 1092 - 1701 - 1702 - 1841 - 1842 - 2901 - 2902 - 8001 - 8002.

### Notes

- Only for coverings in leather, insert in RIO will be applied (Pic.1). Please refer to COVERING HI-TECH folder to choose the color of RIO.
- Fabric insert in RIO cannot be applied for coverings in fabric. In that case a simple stitching will be realized (Pic.2).
- Fabric insert in RIO cannot be applied for coverings in leather Nobile (or leathers thicker than 1.8 mm). In that case a simple stitching will be realized (Pic.3).
- For all leathers without insert RIO, well be realized a simple stitching (Pic.3).
- Other typologies of combined coverings not available.

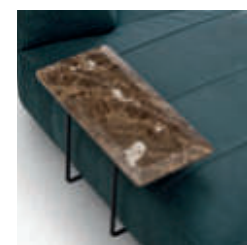

Tavolino terminale // Terminal table



Gunmetal



Contenitore in legno // wooden storage



Canaletto Walnut

Cuciture // Stitching



Fig. 1

Fig. 2

Fig. 3

Poggiatesta // Headrest



### Versioni \ Versions

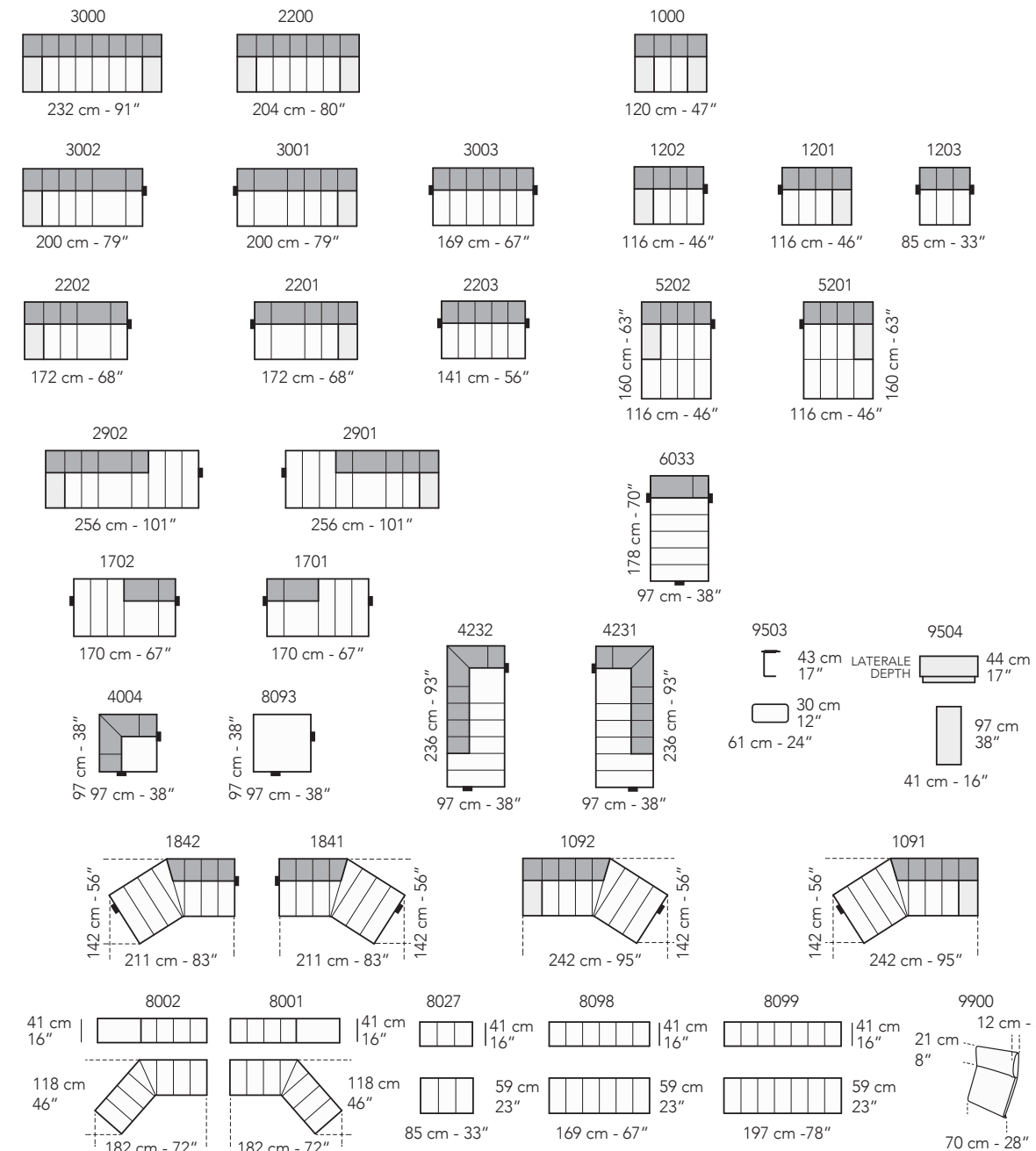

technical sheet

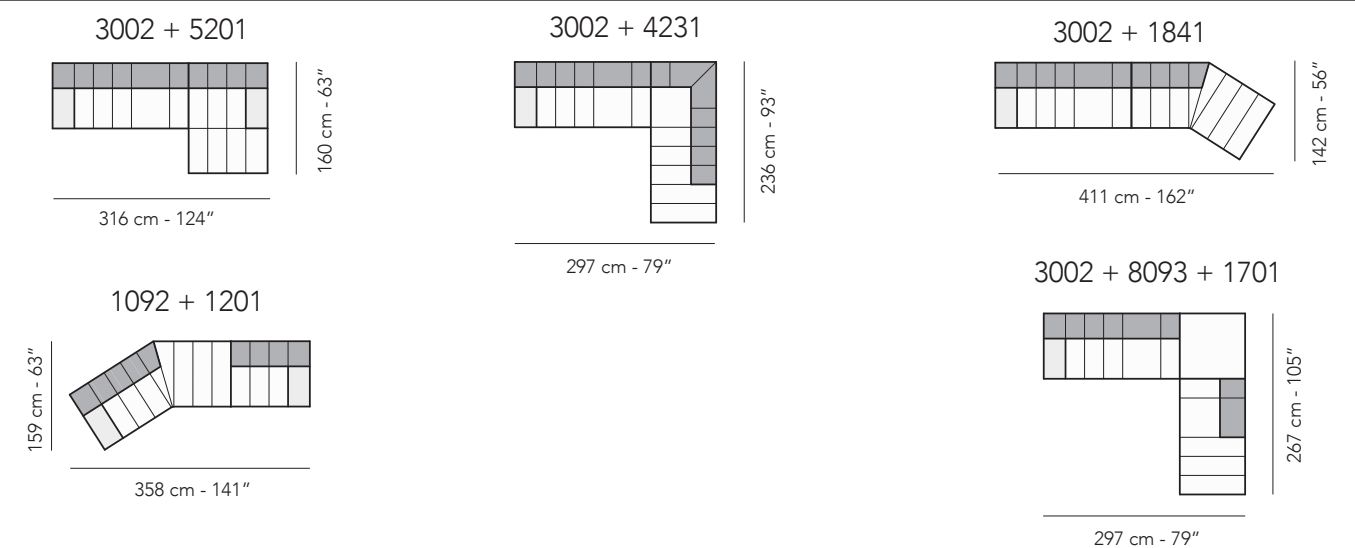

Composizioni consigliate - Recommended compositions

### Legenda - Legend

- Spalliera / Back Cushions
- Poggiaieni / Kidneyrest
- Bracciolo / Armrest
- Marmo / Marble
- Legno / Wood
- Aggancio Componibile / Connector

- Seduta / Seat Cushions
- Ⓢ Sistema Sound

\* Lato terminale sempre rifinito e agganciabile agli elementi componibili / Terminal side is always finished and it can also be connected to modular elements



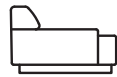

# Zara Deep

Design Application N° 40201800002313



frontale - front

laterale - depth

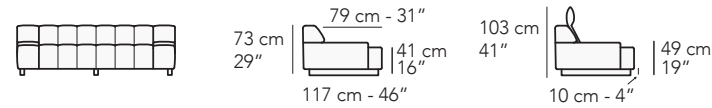

schede tecniche

### Caratteristiche standard

- Struttura in legno e multistrato, molleggio seduta e schienale con cinghie elastiche.
- Imbottitura in poliuretano espanso ecologico a cellula aperta con densità differenziate, rivestito da falda di Tecnoform.
- Rivestimento in pelle o tessuto. Tutti i rivestimenti sono fissi.
- Piedi in legno Laccato nero lucido (Cod.27).
- Il tavolino centrale Cod.9504 è disponibile con finitura Noce canaletto (Cod.10).
- Inserimento letto non possibile.
- Lato componibile rifinito.

### Caratteristiche optional su richiesta senza maggiorazione

- Disponibile con cucitura a contrasto. Per la scelta del colore fare riferimento ai codici del campionario pelli.

### Caratteristiche optional su richiesta con maggiorazione

- Poggiatesta (Cod.9900) con imbottitura in poliuretano espanso e supporto in metallo rivestito.
- Tavolino terminale (Cod.9503) con struttura in metallo Canna di fucile (Cod.50) e ripiano in marmo Emperador (Cod.EM) oppure con marmo bianco Carrara (Cod.CA) fissato alla struttura, per le versioni Cod.D1091 - D1092 - D1701 - D1702 - D1841 - D1842 - D2901 - D2902 - D8001 - D8002.

### Note

- Solo per il rivestimento in pelle, sarà realizzato l'inserto in RIO (Fig.1). Per la scelta del colore fare riferimento alla cartellina COVERING HI-TECH.
- NON è possibile realizzare l'inserto in RIO per il rivestimento in tessuto. In tal caso sarà realizzata cucitura semplice (Fig.2).
- NON è possibile realizzare l'inserto in RIO per il rivestimento in pelle NOBILE e con spessori di pelle superiori a 1.8 mm. In tal caso sarà realizzata cucitura semplice (Fig. 3).
- Per tutte le pelli senza inserto RIO, sarà realizzata una cucitura semplice (Fig. 3)
- Non è possibile realizzare altre tipologie di rivestimento coordinato.

### Standard features

- *Frame: wooden structure, seat and back suspensions in reinforced elastic webbing.*
- *Padding in eco-friendly open cell polyurethane foam, with different densities, covered with a Tecnoform layer.*
- *Covering: in leather or fabric. Not removable coverings.*
- *Wooden legs in Black gloss lacquer (Cod.27).*
- *Central table Cod.9504 available with Canaletto walnut (Cod.10) finishing.*
- *No bed version available.*
- *Sectional sides finished.*

### Optional features without any upcharge

- *Contrast stitching available. Please refer to our leather collection for a thread color indication.*

### Optional features with upcharge

- *Headrest (Cod.9900) with padding in eco-friendly open cell polyurethane foam and covered metal support.*
- *Terminal table (Cod.9503) with metal structure in Gunmetal (Cod.50) color and top in Emperador marble (Cod.EM) or Carrara white marble (Cod.CA) attached to the structure available for the versions Cod.D1091 - D1092 - D1701 - D1702 - D1841 - D1842 - D2901 - D2902 - D8001 - D8002.*

### Notes

- *Only for coverings in leather, insert in RIO will be applied (Pic.1). Please refer to COVERING HI-TECH folder to choose the color of RIO.*
- *Fabric insert in RIO cannot be applied for coverings in fabric. In that case a simple stitching will be realized (Pic.2).*
- *Fabric insert in RIO cannot be applied for coverings in leather Nobile (or leathers thicker than 1.8 mm). In that case a simple stitching will be realized (Pic.3).*
- *For all leathers without insert RIO, well be realized a simple stitching (Pic.3).*
- *Other typologies of combined coverings not available.*

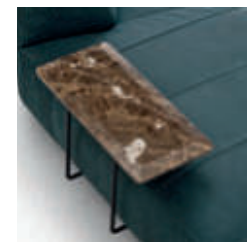

Tavolino terminale // Terminal table

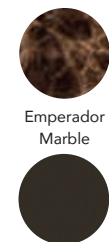

Emperador Marble  
Gunmetal

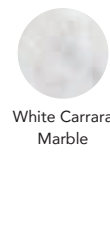

White Carrara Marble

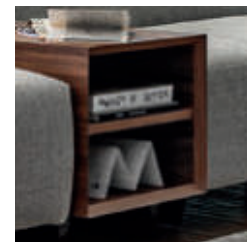

Contenitore in legno // wooden storage



Canaletto Walnut

Cuciture // Stitching

Tessuto // Fabric  
Pelle // Leather



Fig. 1



Fig. 2

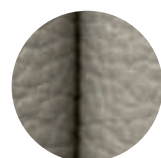
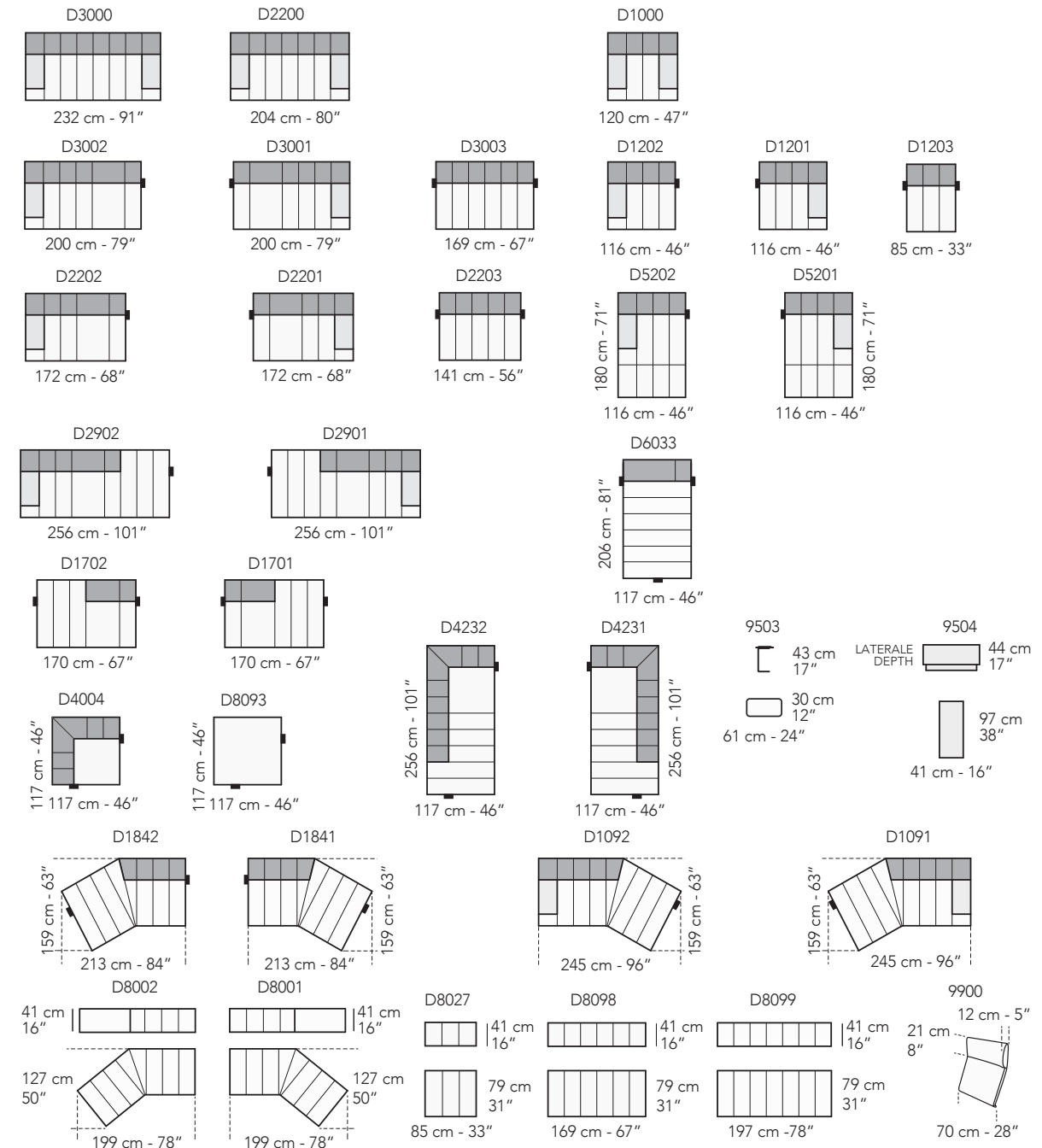

Fig. 3

Poggiatesta // Headrest



### Versioni \ Versions



technical sheet

D3002 + D4231

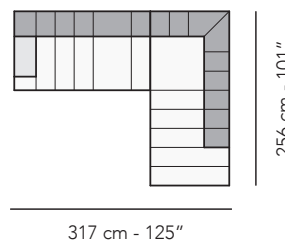

D1092 + D2201

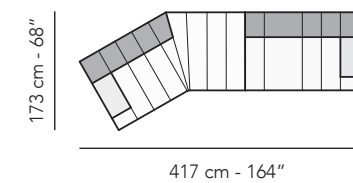

D2902 + D4231

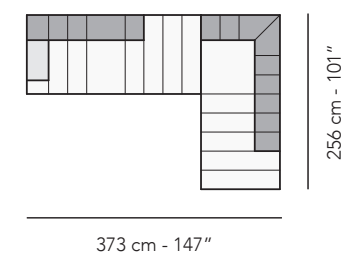

### Composizioni consigliate - Recommended compositions

### Legenda - Legend

- Spalliera / Back Cushions
- Poggiaieni / Kidneyrest
- Bracciolo / Armrest
- Marmo / Marble
- Legno / Wood
- Aggancio Componibile / Connector

- Seduta / Seat Cushions
- Sistema Sound

\* Lato terminale sempre rifinito e agganciabile agli elementi componibili / Terminal side is always finished and it can also be connected to modular elements





# Zara Light

design application N° 40201900000467



frontale - front

laterale - depth

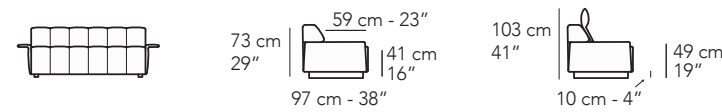

schede tecniche

### Caratteristiche standard

- Struttura in legno e multistrato, molleggio seduta e schienale con cinghie elastiche.
- Struttura bracciolo in metallo rivestito in poliuretano espanso.
- Imbottitura in poliuretano espanso ecologico a cellula aperta con densità differenziate rivestito da falda di Tecnoform.
- Rivestimento in pelle o tessuto. Tutti i rivestimenti sono fissi.
- Per tutte le versioni (dove previsto) il bracciolo sarà realizzato esclusivamente in pelle.
- Piedi in legno Laccato nero lucido (Cod.27).
- Il tavolino centrale Cod.9504 è disponibile con finitura Noce canaletto (Cod.10).
- Inserimento letto non possibile.
- Lato componibile rifinito.

### Caratteristiche optional su richiesta senza maggiorazione

- Disponibile con cucitura a contrasto. Per la scelta del colore fare riferimento ai codici del campionario pelli.

### Caratteristiche optional su richiesta con maggiorazione

- Poggiatesta (Cod.9900) con imbottitura in poliuretano espanso e supporto in metallo rivestito.
- Tavolino terminale (Cod.9503) con struttura in metallo Canna di fucile (Cod.50) e ripiano in marmo Emperador (Cod.EM) oppure con marmo bianco Carrara (Cod.CA) fissato alla struttura, per le versioni Cod.L1091 - L1092 - L1701 - L1702 - L1791 - L1792 - L1841 - L1842 - L8001 - L8002.

### Note

- Solo per il rivestimento in pelle, sarà realizzato l'insero in RIO (Fig.1). Per la scelta del colore fare riferimento alla cartellina COVERING HI-TECH.
- NON è possibile realizzare l'insero in RIO per il rivestimento in tessuto. In tal caso sarà realizzata cucitura semplice (Fig.2).
- NON è possibile realizzare l'insero in RIO per il rivestimento in pelle NOBILE e con spessori di pelle superiori a 1.8 mm. In tal caso sarà realizzata cucitura semplice (Fig. 3).
- Per tutte le pelli senza inserto RIO, sarà realizzata una cucitura semplice (Fig. 3).
- Non è possibile realizzare altre tipologie di rivestimento coordinato.

### Standard features

- *Frame: wooden structure, seat and back suspensions in reinforced elastic webbing.*
- *Armrest in metal structure covered with open cell polyurethane foam.*
- *Padding in eco-friendly open cell polyurethane foam, with different densities, covered with a Tecnoform layer.*
- *Covering in leather or fabric. Not removable coverings.*
- *For all versions (where applicable) armrest will be realized with covering in leather.*
- *Wooden legs in Black gloss lacquer (Cod.27).*
- *Central table Cod.9504 available with Canaletto walnut (Cod.10) finishing.*
- *No bed version available.*
- *Sectional sides finished.*

### Optional features without any upcharge

- *Contrast stitching available. Please refer to our leather collection for a thread color indication.*

### Optional features with upcharge

- *Headrest (Cod.9900) with padding in eco-friendly open cell polyurethane foam and covered metal support.*
- *Terminal table (Cod.9503) with metal structure in Gunmetal (Cod.50) color and top in Emperador marble (Cod.EM) or Carrara white marble (Cod.CA) attached to the structure available for the versions Cod.L1091 - L1092 - L1701 - L1702 - L1791 - L1792 - L1841 - L1842 - L8001 - L8002.*

### Notes

- *Only for coverings in leather, insert in RIO will be applied (Pic.1). Please refer to COVERING HI-TECH folder to choose the color of RIO.*
- *Fabric insert in RIO cannot be applied for coverings in fabric. In that case a simple stitching will be realized (Pic.2).*
- *Fabric insert in RIO cannot be applied for coverings in leather Nobile (or leathers thicker than 1.8 mm). In that case a simple stitching will be realized (Pic.3).*
- *For all leathers without insert RIO, will be realized a simple stitching (Pic.3).*
- *Other typologies of combined coverings not available.*

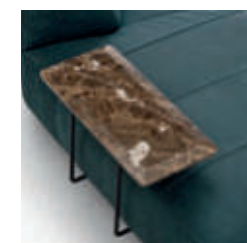

Tavolino terminale // Terminal table



Emperador Marble



White Carrara Marble



Gunmetal



Contenitore in legno // wooden storage



Canaletto Walnut

Cuciture // Stitching

Tessuto // Fabric

Pelle // Leather



Fig. 1



Fig. 2

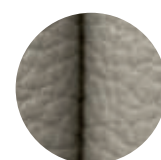
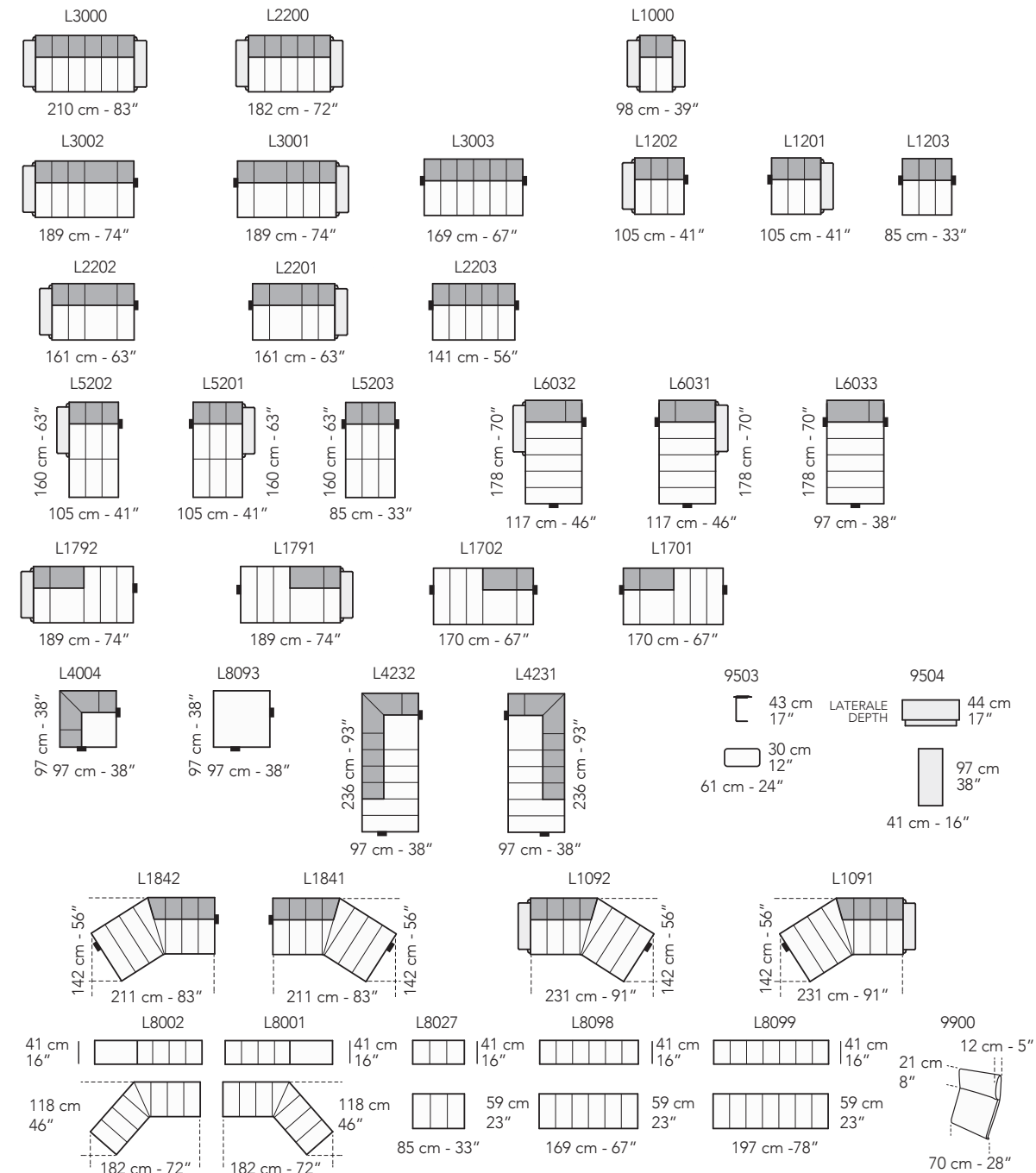

Fig. 3

Poggiatesta // Headrest



### Versioni \ Versions



technical sheet

L3002 + L4231

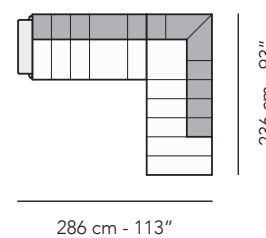

286 cm - 113"

L3002 + L6031

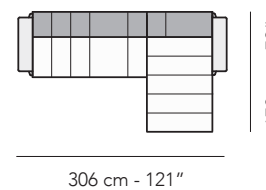

306 cm - 121"

L3002 + L6031 + L1201

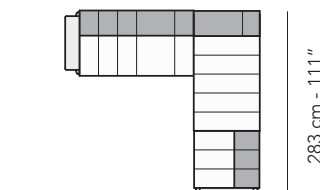

306 cm - 121"

### Composizioni consigliate - Recommended compositions

### Legenda - Legend

- Spalliera / Back Cushions
- Poggiaresi / Kidneyrest
- Bracciolo / Armrest
- Marmo / Marble
- Legno / Wood
- Aggancio Componibile / Connector

- Seduta / Seat Cushions
- Ⓢ Sistema Sound

\* Lato terminale sempre rifinito e agganciabile agli elementi componibili / Terminal side is always finished and it can also be connected to modular elements



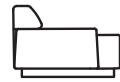

# Zara Light Deep



frontale - front

laterale - depth

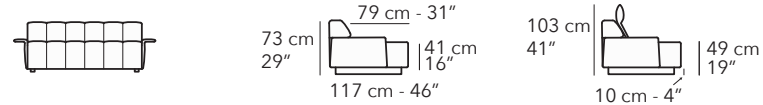

schede tecniche

### Caratteristiche standard

- Struttura in legno e multistrato, molleggio seduta e schienale con cinghie elastiche.
- Struttura bracciolo in metallo rivestito in poliuretano espanso.
- Imbottitura in poliuretano espanso ecologico a cellula aperta con densità differenziate rivestito da falda di Tecnoform.
- Rivestimento in pelle o tessuto. Tutti i rivestimenti sono fissi.
- Per tutte le versioni (dove previsto) il bracciolo sarà realizzato esclusivamente in pelle.
- Piedi in legno Laccato nero lucido (Cod.27).
- Il tavolino centrale Cod.9504 è disponibile con finitura Noce canaletto (Cod.10).
- Inserimento letto non possibile.
- Lato componibile rifinito.

### Caratteristiche optional su richiesta senza maggiorazione

- Disponibile con cucitura a contrasto. Per la scelta del colore fare riferimento ai codici del campionario pelli.

### Caratteristiche optional su richiesta con maggiorazione

- Poggiatesta (Cod.9900) con imbottitura in poliuretano espanso e supporto in metallo rivestito.
- Tavolino terminale (Cod.9503) con struttura in metallo Canna di fucile (Cod.50) e ripiano in marmo Emperador (Cod.EM) oppure con marmo bianco Carrara (Cod.CA) fissato alla struttura, per le versioni Cod.LD1091 - LD1092 - LD1701 - LD1702 - LD1791 - LD1792 - LD1841 - LD1842 - LD8001 - LD8002.

### Note

- Solo per il rivestimento in pelle, sarà realizzato l'inserto in RIO (Fig.1). Per la scelta del colore fare riferimento alla cartellina COVERING HI-TECH.
- NON è possibile realizzare l'inserto in RIO per il rivestimento in tessuto. In tal caso sarà realizzata cucitura semplice (Fig.2).
- NON è possibile realizzare l'inserto in RIO per il rivestimento in pelle NOBILE e con spessori di pelle superiori a 1.8 mm. In tal caso sarà realizzata cucitura semplice (Fig. 3).
- Per tutte le pelli senza inserto RIO, sarà realizzata una cucitura semplice (Fig. 3).
- Non è possibile realizzare altre tipologie di rivestimento coordinato.

### Standard features

- *Frame: wooden structure, seat and back suspensions in reinforced elastic webbing.*
- *Armrest in metal structure covered with open cell polyurethane foam.*
- *Padding in eco-friendly open cell polyurethane foam, with different densities, covered with a Tecnoform layer.*
- *Covering in leather or fabric. Not removable coverings.*
- *For all versions (where applicable) armrest will be realized with covering in leather.*
- *Wooden legs in Black gloss lacquer (Cod.27).*
- *Central table Cod.9504 available with Canaletto walnut (Cod.10) finishing.*
- *No bed version available.*
- *Sectional sides finished.*

### Optional features without any upcharge

- *Contrast stitching available. Please refer to our leather collection for a thread color indication.*

### Optional features with upcharge

- *Headrest (Cod.9900) with padding in eco-friendly open cell polyurethane foam and covered metal support.*
- *Terminal table (Cod.9503) with metal structure in Gunmetal (Cod.50) color and top in Emperador marble (Cod.EM) or Carrara white marble (Cod.CA) attached to the structure available for the versions Cod.LD1091 - LD1092 - LD1701 - LD1702 - LD1791 - LD1792 - LD1841 - LD1842 - LD8001 - LD8002.*

### Notes

- *Only for coverings in leather, insert in RIO will be applied (Pic.1). Please refer to COVERING HI-TECH folder to choose the color of RIO.*
- *Fabric insert in RIO cannot be applied for coverings in fabric. In that case a simple stitching will be realized (Pic.2).*
- *Fabric insert in RIO cannot be applied for coverings in leather Nobile (or leathers thicker than 1.8 mm). In that case a simple stitching will be realized (Pic.3).*
- *For all leathers without insert RIO, will be realized a simple stitching (Pic.3).*
- *Other typologies of combined coverings not available.*

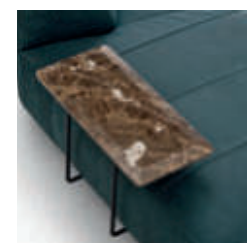

Tavolino terminale // Terminal table



Gunmetal



Contenitore in legno // wooden storage



Canaletto Walnut

Cuciture // Stitching

Tessuto // Fabric

Pelle // Leather



Fig. 1

Fig. 2

Fig. 3

Poggiatesta // Headrest



### Versioni \ Versions

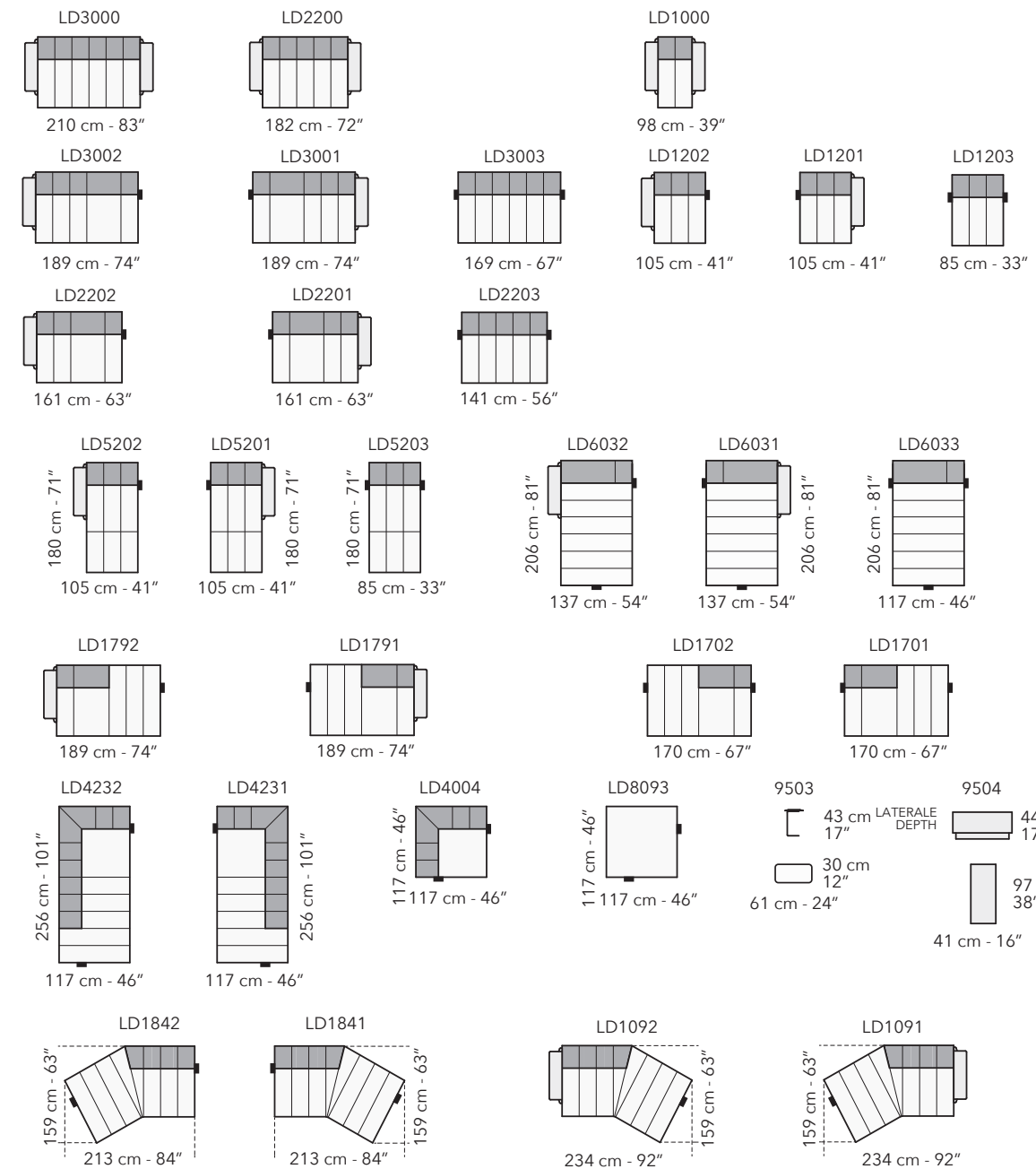

technical sheet

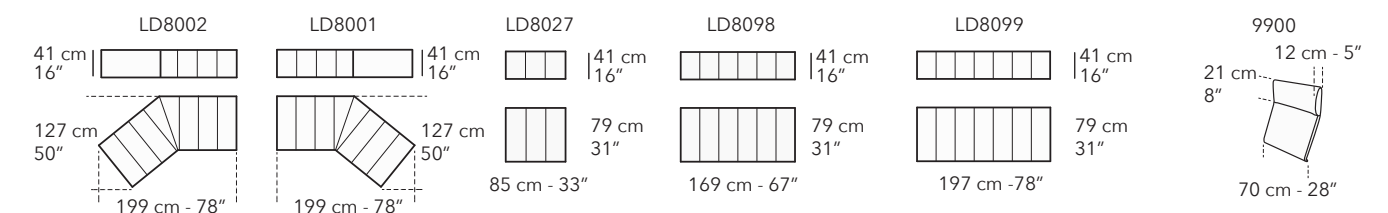

LD3002 + LD6031

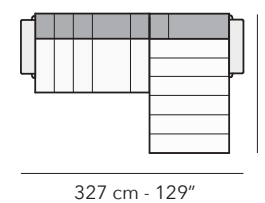

327 cm - 129"

LD3002 + LD4231

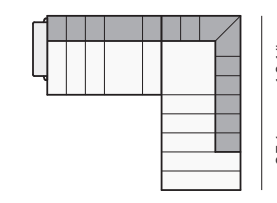

305 cm - 120"

LD1092 + LD1201

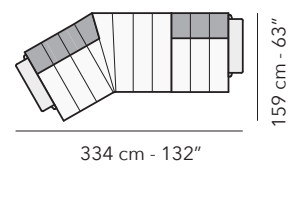

334 cm - 132"

### Composizioni consigliate - Recommended compositions

### Legenda - Legend

- Spalliera / Back Cushions
- Poggiatesta / Kidneyrest
- Bracciolo / Armrest
- Marmo / Marble
- Legno / Wood
- Aggancio Componibile / Connector

- Seduta / Seat Cushions
- Sistema Sound

\* Lato terminale sempre rifinito e agganciabile agli elementi componibili / Terminal side is always finished and it can also be connected to modular elements





# Zara Cuoio

design application N° 40201900000467



frontale - front

laterale - depth

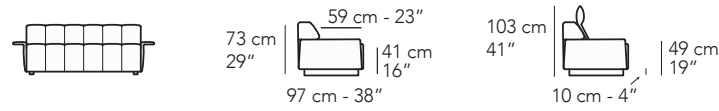

### Caratteristiche standard

- Struttura in legno e multistrato, molleggio seduta e schienale con cinghie elastiche.
- Struttura bracciolo in metallo.
- Imbottitura in poliuretano espanso ecologico a cellula aperta con densità differenziate rivestito da falda di Tecnoform.
- Rivestimento in pelle o tessuto. Tutti i rivestimenti sono fissi.
- Per tutte le versioni (dove previsto) il bracciolo è realizzato in cuoio, disponibile nelle seguenti colorazioni: Avorio (Cod.C01), Sabbia (Cod.C02), Naturale (Cod.C03), Terracotta (Cod.C04), Tortora (Cod.C05), Grigio scuro (Cod.C06), Verde salvia (Cod.C07), Verde fango (Cod.C08), Castagna (Cod.C09), Testa di moro (Cod.C10).
- Piedi in legno Laccato nero lucido (Cod.27).
- Il tavolino centrale Cod.9504 è disponibile con finitura Noce canaletto (Cod.10).
- Inserimento letto non possibile.
- Lato componibile rifinito.

### Caratteristiche optional su richiesta senza maggiorazione

- Disponibile con cucitura a contrasto. Per la scelta del colore fare riferimento ai codici del campionario pelli.

### Caratteristiche optional su richiesta con maggiorazione

- Poggiatesta (Cod.9900) con imbottitura in poliuretano espanso e supporto in metallo rivestito.
- Tavolino terminale (Cod.9503) con struttura in metallo Canna di fucile (Cod.50) e ripiano in marmo Emperador (Cod.EM) oppure con marmo bianco Carrara (Cod.CA) fissato alla struttura, per le versioni Cod.C1091 - C1092 - C1701 - C1702 - C1791 - C1792 - C1841 - C1842 - C8001 - C8002.

### Note

- Solo per il rivestimento in pelle, sarà realizzato l'insero in RIO (Fig.1). Per la scelta del colore fare riferimento alla cartellina COVERING HI-TECH.
- NON è possibile realizzare l'insero in RIO per il rivestimento in tessuto. In tal caso sarà realizzata cucitura semplice (Fig.2).
- NON è possibile realizzare l'insero in RIO per il rivestimento in pelle NOBILE e con spessori di pelle superiori a 1.8 mm. In tal caso sarà realizzata cucitura semplice (Fig. 3).
- Per tutte le pelli senza inserto RIO, sarà realizzata una cucitura semplice (Fig. 3).
- Non è possibile realizzare altre tipologie di rivestimento coordinato.

### Standard features

- Frame: wooden structure, seat and back suspensions in reinforced elastic webbing.
- Armrest in metal structure.
- Padding in eco-friendly open cell polyurethane foam, with different densities covered with a Tecnoform layer.
- Covering in leather or fabric. Not removable coverings.
- For all versions (where applicable) armrest will be realized with covering in hide leather, available in the following colors: Avorio (Cod.C01), Sabbia (Cod.C02), Naturale (Cod.C03), Terracotta (Cod.C04), Tortora (Cod.C05), Grigio scuro (Cod.C06), Verde salvia (Cod.C07), Verde fango (Cod.C08), Castagna (Cod.C09), Testa di moro (Cod.C10).
- Wooden legs in Black gloss lacquer (Cod.27).
- Central table Cod.9504 available with Canaletto walnut (Cod.10) finishing.
- No bed version available.
- Sectional sides finished.

### Optional features without any upcharge

- Contrast stitching available. Please refer to our leather collection for a thread color indication.

### Optional features with upcharge

- Headrest (Cod.9900) with padding in eco-friendly open cell polyurethane foam and covered metal support.
- Terminal table (Cod.9503) with metal structure in Gunmetal (Cod.50) color and top in Emperador marble (Cod.EM) or Carrara white marble (Cod.CA) attached to the structure available for the versions Cod.C1091 - C1092 - C1701 - C1702 - C1791 - C1792 - C1841 - C1842 - C8001 - C8002.

### Notes

- Only for coverings in leather, insert in RIO will be applied (Pic.1). Please refer to COVERING HI-TECH folder to choose the color of RIO.
- Fabric insert in RIO cannot be applied for coverings in fabric. In that case a simple stitching will be realized (Pic.2).
- Fabric insert in RIO cannot be applied for coverings in leather Nobile (or leathers thicker than 1.8 mm). In that case a simple stitching will be realized (Pic.3).
- For all leathers without insert RIO, will be realized a simple stitching (Pic.3).
- Other typologies of combined coverings not available.

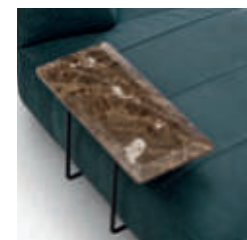

Tavolino terminale // Terminal table



Gunmetal

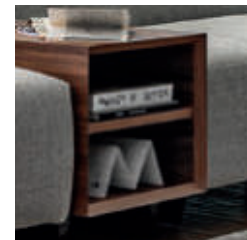

Contenitore in legno // wooden storage

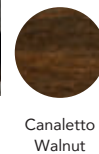

Canaletto Walnut

Cuciture // Stitching

Tessuto  
Fabric  
Pelle  
Leather

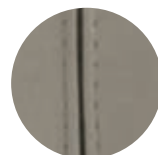

Fig. 1



Fig. 2

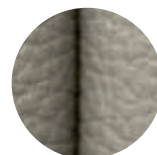
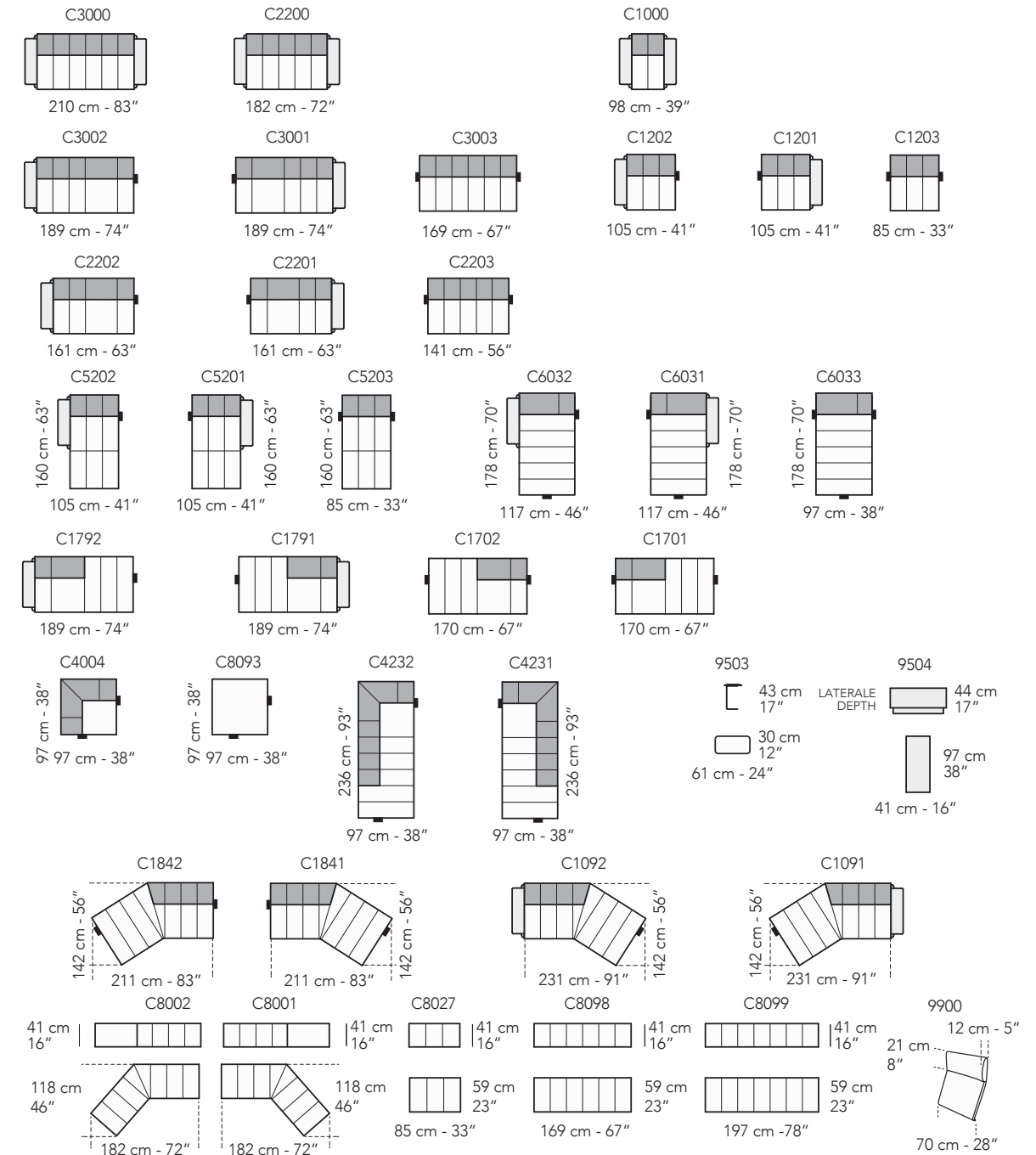

Fig. 3

Poggiatesta // Headrest



### Versioni \ Versions



C3002 + C4231

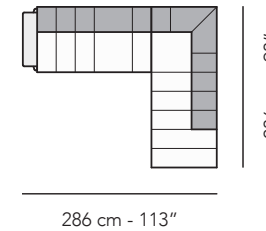

286 cm - 113"

C3002 + C6031

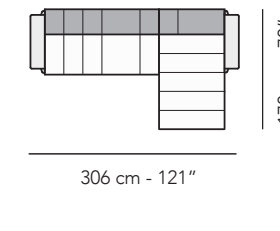

306 cm - 121"

C3002 + C6031 + C1201

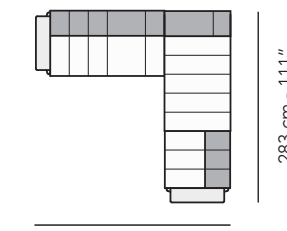

306 cm - 121"

### Composizioni consigliate - Recommended compositions

### Legenda - Legend

- Spalliera / Back Cushions
- Poggiaresi / Kidneyrest
- Bracciolo / Armrest
- Marmo / Marble
- Legno / Wood
- Aggancio Componibile / Connector

- Seduta / Seat Cushions
- Sistema Sound

\* Lato terminale sempre rifinito e agganciabile agli elementi componibili / Terminal side is always finished and it can also be connected to modular elements



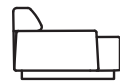

# Zara Cuoio Deep

Design Application N° 402018000002313



frontale - front

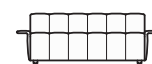

laterale - depth

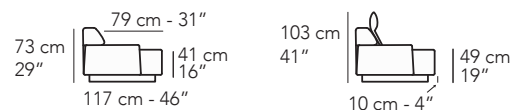

## Caratteristiche standard

- Struttura in legno e multistrato, molleggio seduta e schienale con cinghie elastiche.
- Struttura bracciolo in metallo.
- Imbottitura in poliuretano espanso ecologico a cellula aperta con densità differenziate rivestito da falda di Tecnoform.
- Rivestimento in pelle o tessuto. Tutti i rivestimenti sono fissi.
- Per tutte le versioni (dove previsto) il bracciolo è realizzato in cuoio, disponibile nelle seguenti colorazioni: Avorio (Cod.C01), Sabbia (Cod.C02), Naturale (Cod.C03), Terracotta (Cod.C04), Tortora (Cod.C05), Grigio scuro (Cod.C06), Verde salvia (Cod.C07), Verde fango (Cod.C08), Castagna (Cod.C09), Testa di moro (Cod.C10).
- Piedi in legno Laccato nero lucido (Cod.27).
- Il tavolino centrale Cod.9504 è disponibile con finitura Noce canaletto (Cod.10).
- Inserimento letto non possibile.
- Lato componibile rifinito.

## Caratteristiche optional su richiesta senza maggiorazione

- Disponibile con cucitura a contrasto. Per la scelta del colore fare riferimento ai codici del campionario pelli.

## Caratteristiche optional su richiesta con maggiorazione

- Poggiatesta (Cod.9900) con imbottitura in poliuretano espanso e supporto in metallo rivestito.
- Tavolino terminale (Cod.9503) con struttura in metallo Canna di fucile (Cod.50) e ripiano in marmo Emperador (Cod.EM) oppure con marmo bianco Carrara (Cod.CA) fissato alla struttura, per le versioni Cod.CD1091 - CD1092 - CD1701 - CD1702 - CD1791 - CD1792 - CD1841 - CD1842 - CD8001 - CD8002.

## Note

- Solo per il rivestimento in pelle, sarà realizzato l'inserto in RIO (Fig.1). Per la scelta del colore fare riferimento alla cartellina COVERING HI-TECH.
- NON è possibile realizzare l'inserto in RIO per il rivestimento in tessuto. In tal caso sarà realizzata cucitura semplice (Fig.2).
- NON è possibile realizzare l'inserto in RIO per il rivestimento in pelle NOBILE e con spessori di pelle superiori a 1.8 mm. In tal caso sarà realizzata cucitura semplice (Fig. 3).
- Per tutte le pelli senza inserto RIO, sarà realizzata una cucitura semplice (Fig. 3).
- Non è possibile realizzare altre tipologie di rivestimento coordinato.

## Standard features

- Frame: wooden structure, seat and back suspensions in reinforced elastic webbing.
- Armrest in metal structure.
- Padding in eco-friendly open cell polyurethane foam, with different densities, covered with a Tecnoform layer.
- Covering in leather or fabric. Not removable coverings.
- For all versions (where applicable) armrest will be realized with covering in hide leather, available in the following colors: Avorio (Cod.C01), Sabbia (Cod.C02), Naturale (Cod.C03), Terracotta (Cod.C04), Tortora (Cod.C05), Grigio scuro (Cod.C06), Verde salvia (Cod.C07), Verde fango (Cod.C08), Castagna (Cod.C09), Testa di moro (Cod.C10).
- Wooden legs in Black gloss lacquer (Cod.27).
- Central table Cod.9504 available with Canaletto walnut (Cod.10) finishing.
- No bed version available.
- Sectional sides finished.

## Optional features without any upcharge

- Contrast stitching available. Please refer to our leather collection for a thread color indication.

## Optional features with upcharge

- Headrest (Cod.9900) with padding in eco-friendly open cell polyurethane foam and covered metal support.
- Terminal table (Cod.9503) with metal structure in Gunmetal (Cod.50) color and top in Emperador marble (Cod.EM) or Carrara white marble (Cod.CA) attached to the structure available for the versions Cod. CD1091 - CD1092 - CD1701 - CD1702 - CD1791 - CD1792 - CD1841 - CD1842 - CD8001 - CD8002.

## Notes

- Only for coverings in leather, insert in RIO will be applied (Pic.1). Please refer to COVERING HI-TECH folder to choose the color of RIO.
- Fabric insert in RIO cannot be applied for coverings in fabric. In that case a simple stitching will be realized (Pic.2).
- Fabric insert in RIO cannot be applied for coverings in leather Nobile (or leathers thicker than 1.8 mm). In that case a simple stitching will be realized (Pic.3).
- For all leathers without insert RIO, well be realized a simple stitching (Pic.3).
- Other typologies of combined coverings not available.

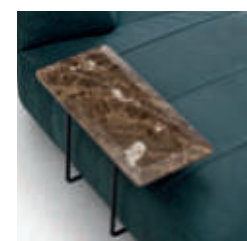

Tavolino terminale // Terminal table



Emperador Marble



White Carrara Marble



Gunmetal



Contenitore in legno // wooden storage



Canaletto Walnut

Cuciture // Stitching

Tessuto // Fabric

Pelle // Leather



Fig. 1



Fig. 2

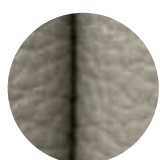
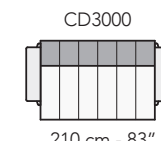

Fig. 3

Poggiatesta // Headrest



## Versioni \ Versions



CD3000

210 cm - 83"

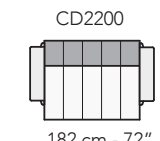

CD2200

182 cm - 72"

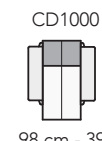

CD1000

98 cm - 39"

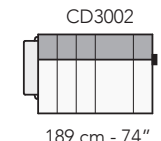

CD3002

189 cm - 74"

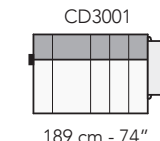

CD3001

189 cm - 74"

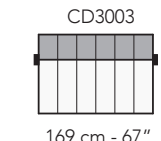

CD3003

169 cm - 67"

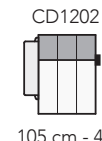

CD1202

105 cm - 41"

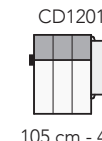

CD1201

105 cm - 41"

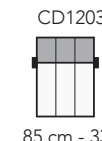

CD1203

85 cm - 33"

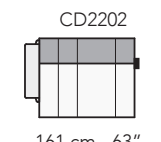

CD2202

161 cm - 63"

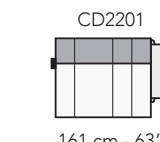

CD2201

161 cm - 63"

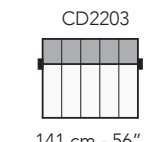

CD2203

141 cm - 56"

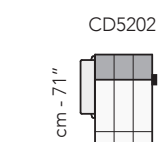

CD5202

180 cm - 71"

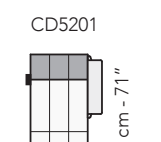

CD5201

180 cm - 71"

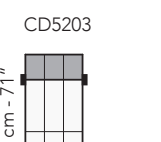

CD5203

180 cm - 71"

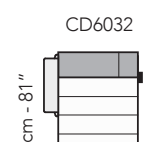

CD6032

206 cm - 81"

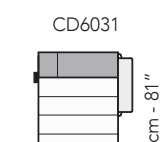

CD6031

206 cm - 81"

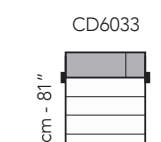

CD6033

206 cm - 81"

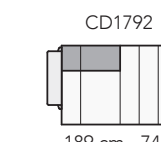

CD1792

189 cm - 74"

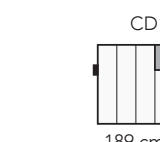

CD1791

189 cm - 74"

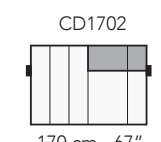

CD1702

170 cm - 67"

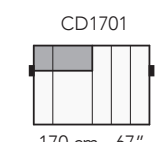

CD1701

170 cm - 67"

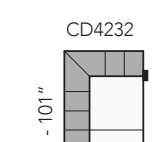

CD4232

256 cm - 101"

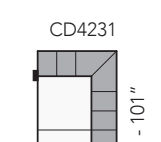

CD4231

256 cm - 101"

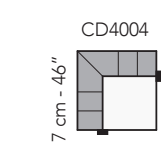

CD4004

117 cm - 46"



CD8093

117 cm - 46"

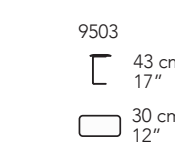

9503

61 cm - 24"

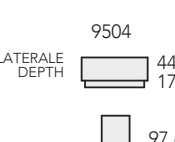

9504

41 cm - 16"

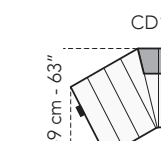

CD1842

213 cm - 84"

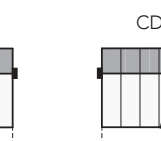

CD1841

213 cm - 84"

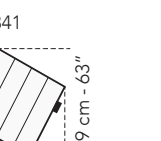

CD1092

234 cm - 92"

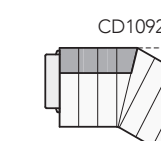

CD1091

234 cm - 92"

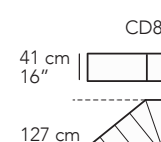

CD8002

127 cm - 50"

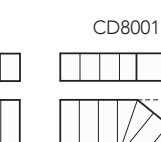

CD8001

127 cm - 50"

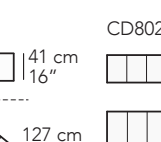

CD8027

85 cm - 33"

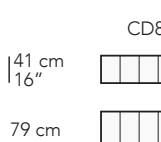

CD8098

169 cm - 67"

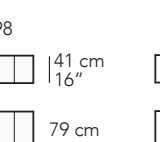

CD8099

197 cm - 78"

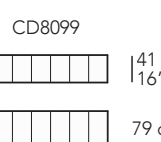

9900

70 cm - 28"

CD3002 + CD6031

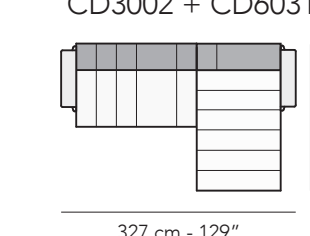

327 cm - 129"

CD3002 + CD4231

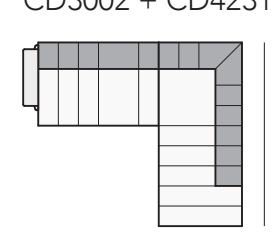

305 cm - 120"

CD1092 + CD1201

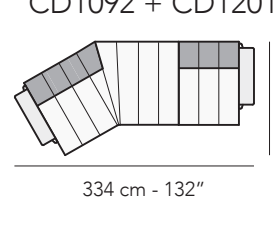

334 cm - 132"

## Composizioni consigliate - Recommended compositions

## Legenda - Legend

- Spalliera / Back Cushions
- Poggiaieni / Kidneyrest
- Bracciolo / Armrest
- Marmo / Marble
- Legno / Wood
- Aggancio Componibile / Connector

- Seduta / Seat Cushions
- Sistema Sound

\* Lato terminale sempre rifinito e agganciabile agli elementi componibili / Terminal side is always finished and it can also be connected to modular elements





**CU 52** 60x60 cm  
24"x24"

**CU 51** 50x50 cm  
20"x20"

**CU 50** 40x40 cm  
16"x16"

**Caratteristiche standard**

- Imbottitura in fibra di poliestere siliconata.
- Rivestimento in pelle o tessuto, entrambi sfoderabili.

**Note**

- Multi rivestimento non disponibile.

**Standard Features**

- Padding in siliconized polyester fiber.
- Covering in leather or fabric. Removable covering.

**Notes**

- Combined coverings not available.



**CU 54** 60x60 cm  
24"x24"

**CU 53** 50x50 cm  
20"x20"

**Caratteristiche standard**

- Imbottitura in misto piuma.
- Rivestimento in pelle o tessuto, entrambi sfoderabili.
- Cucitura Cod.04 per rivestimento in pelle e tessuto.

**Note**

- Non è possibile applicare altre cuciture.
- Multi rivestimento non disponibile.

**Standard Features**

- Padding in mixed feather.
- Covering in leather or fabric. Removable covering.
- Stitching Cod.04 for leather and fabric coverings.

**Notes**

- Other stitchings not available.
- Combined coverings not available.



**CU 56** 60x60 cm  
24"x24"

**CU 55** 50x50 cm  
20"x20"

**Caratteristiche standard**

- Imbottitura in misto piuma.
- Rivestimento in pelle o tessuto, entrambi sfoderabili.

**Note**

- Multi rivestimento non disponibile.

**Standard Features**

- Padding in mixed feather.
- Covering in leather or fabric. Removable covering.

**Notes**

- Combined coverings not available.



**CU 58** 60x60 cm  
24"x24"

**CU 57** 50x50 cm  
20"x20"

**Caratteristiche standard**

- Imbottitura in misto piuma.
- Rivestimento in pelle o tessuto, entrambi sfoderabili.

**Note**

- Multi rivestimento non disponibile.

**Standard Features**

- Padding in mixed feather.
- Covering in leather or fabric. Removable covering.

**Notes**

- Combined coverings not available.



**CU 60** 60x60 cm  
24"x24"

**CU 59** 50x50 cm  
20"x20"

**Caratteristiche standard**

- Imbottitura in misto piuma.
- Rivestimento in pelle o tessuto, entrambi sfoderabili.

**Note**

- Multi rivestimento non disponibile.

**Standard Features**

- Padding in mixed feather.
- Covering in leather or fabric. Not removable coverings.

**Notes**

- Combined coverings not available.



**CU 61** 55x55 cm  
22"x22"

**Caratteristiche standard**

- Imbottitura in misto piuma.
- Rivestimento in pelle o tessuto, entrambi sfoderabili.
- Cucitura Cod.04 per rivestimento in pelle e tessuto.

**Note**

- Non è possibile applicare altre cuciture.
- Multi rivestimento non disponibile.

**Standard Features**

- Padding in mixed feather.
- Covering in leather or fabric. Removable covering.
- Stitching Cod.04 for leather and fabric coverings.

**Notes**

- Different stitchings not available.
- Combined coverings not available.







CU 63 55x45 cm  
22"x18"

**Caratteristiche standard**  
- Imbottitura in misto piuma.  
- Rivestimento in pelle o tessuto, entrambi sfoderabili.  
- Cucitura Cod.03 per rivestimento in pelle e tessuto.

**Note**  
- Non è possibile applicare altre cuciture.  
- Multi rivestimento non disponibile.

**Standard Features**  
- Padding in mixed feather.  
- Covering in leather or fabric. Removable covering.  
- Stitching Cod.03 for leather and fabric coverings.

**Notes**  
- Different stitchings not available.  
- Combined coverings not available.



CU 64 56x16 cm  
22"x6"

**Caratteristiche standard**  
- Imbottitura in poliuretano espanso ecologico.  
- Rivestimento in pelle o tessuto, entrambi sfoderabili.  
- Cucitura Cod.18 per rivestimento in pelle e tessuto.

**Note**  
- Non è possibile applicare altre cuciture.  
- Multi rivestimento non disponibile.

**Standard Features**  
- Eco-friendly polyurethane foam.  
- Available in leather or fabric removable coverings.  
- Stitching type Cod.18 for leather or fabric coverings.

**Notes**  
- Different stitchings not available.  
- Combined coverings not available.



CU 65 70x30 cm  
28"x12"

**Caratteristiche standard**  
- Imbottitura in misto piuma.  
- Rivestimento in pelle o tessuto, entrambi sfoderabili.  
- Cucitura Cod.12 per rivestimento in pelle e tessuto.

**Note**  
- Non è possibile applicare altre cuciture.  
- Multi rivestimento non disponibile.

**Standard Features**  
- Padding in mixed feather.  
- Covering in leather or fabric. Removable covering.  
- Stitching Cod.12 for leather and fabric coverings.

**Notes**  
- Different stitchings not available.  
- Combined coverings not available.

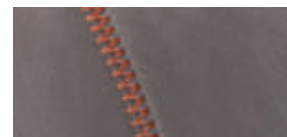

CU 66 70x30 cm  
28"x12"

**Caratteristiche standard**  
- Imbottitura in misto piuma.  
- Rivestimento in pelle o tessuto, entrambi sfoderabili.  
- Cucitura Cod.03 per rivestimento in pelle e tessuto.  
- Cerniera (Cod.Cer.02) nelle finiture: Ottone (Cod.OT), Argento (Cod.AR) e Canna di fucile (Cod.CF).

**Note**  
- Non è possibile applicare altre cuciture.  
- Multi rivestimento non disponibile.

**Standard Features**  
- Padding in mixed feather.  
- Covering in leather or fabric. Removable covering.  
- Stitching Cod.03 for leather and fabric coverings.  
- Cushions zip (Cod.Cer.02) in the following colors: Brass (Cod.OT), Silver (Cod.AR) or Gunmetal (Cod.CF).

**Notes**  
- Different stitchings not available.  
- Combined coverings not available.



CU 67 70x30 cm  
28"x12"

**Caratteristiche standard**  
- Imbottitura in misto piuma.  
- Rivestimento in pelle o tessuto, entrambi sfoderabili.

**Note**  
- Multi rivestimento non disponibile.

**Standard Features**  
- Padding in mixed feather.  
- Covering in leather or fabric. Removable covering.

**Notes**  
- Combined coverings not available.



CU 69 70x40 cm  
28"x16"

CU 68 60x30 cm  
24"x12"

**Caratteristiche standard**  
- Imbottitura in misto piuma.  
- Rivestimento in pelle o tessuto, entrambi sfoderabili.

**Note**  
- Multi rivestimento non disponibile.

**Standard Features**  
- Padding in mixed feather.  
- Covering in leather or fabric. Removable covering.

**Notes**  
- Combined coverings not available.





CU 70 64x30 cm  
25"x12"

**Caratteristiche standard**  
 - Imbottitura in fibra di poliestere siliconata.  
 - Rivestimento in pelle.  
 - Frontale cuscino con punti cucitura eseguiti a mano.

**Note**  
 - Multi rivestimento non disponibile.

**Standard Features**  
 - Padding in siliconized polyester fiber.  
 - Covering in leather.  
 - Frontal part of the cushion enriched by handmade stitching.

**Notes**  
 - Combined coverings not available.



CU 71 55x55 cm  
22"x22"

**Caratteristiche standard**  
 - Imbottitura in fibra di poliestere siliconata.  
 - Rivestimento in pelle.

**Note**  
 - Multi rivestimento non disponibile.

**Standard Features**  
 - Padding in siliconized polyester fiber.  
 - Covering in leather.

**Notes**  
 - Combined coverings not available.



CU 72 80x80 cm  
31"x31"

**Caratteristiche standard**  
 - Imbottitura in misto piuma.  
 - Rivestimento in pelle o tessuto, entrambi sfoderabili.  
 - Cucitura Cod.03 per rivestimento in pelle.

**Note**  
 - Multi rivestimento non disponibile.

**Standard Features**  
 - Padding in mixed feather.  
 - Covering in leather or fabric. Removable covering.  
 - Stitching Cod.03 for leather coverings.

**Notes**  
 - Combined coverings not available.



La ditta si riserva il diritto di apportare in ogni momento modifiche tecniche ed estetiche. La stampa tipografica non sempre permette la fedele riproduzione dei colori e delle tinte rispetto agli originali. \\ The company reserves the right to change, at any time and without prior warning, the technical specifications and dimensions of the articles.



Cordinated by  
Nicoline Marketing Department

Thanks to:

. Francesca Sassi

Credits:

. Signum Contract

**nicoline**  
ITALIA

**Nicoline Salotti S.r.l.**

C.da Parchi Calia s.n. – Z.I. Pip 70022 Altamura (Bari) - Italy T +39 080 3101487

info@nicoline.it - www.nicoline.it



